

DATA SHEET



PCF8535

65 × 133 pixel matrix driver

Objective specification
File under Integrated Circuits, IC12

1999 Aug 24

65 × 133 pixel matrix driver**PCF8535****CONTENTS**

1	FEATURES	7.10	Bias system
2	APPLICATIONS	7.10.1	Set bias system
3	GENERAL DESCRIPTION	7.11	Temperature measurement
4	ORDERING INFORMATION	7.11.1	Temperature read back
5	BLOCK DIAGRAM	7.12	Temperature compensation
5.1	Block diagram functions	7.12.1	Temperature coefficients
5.1.1	Oscillator	7.13	V _{OP}
5.1.2	Power-on reset	7.13.1	Set V _{OP} value
5.1.3	I ² C-bus controller	7.14	Voltage multiplier control
5.1.4	Input filters	7.14.1	S[1:0]
5.1.5	Display data RAM	7.15	Addressing
5.1.6	Timing generator	7.15.1	Input addressing
5.1.7	Address counter	7.15.2	Output addressing
5.1.8	Display address counter	7.16	Instruction set
6	PINNING	7.16.1	RAM read/write command page
6.1	Pin functions	7.16.2	Function and RAM command page
6.1.1	R0 to R64	7.16.3	Display setting command page
6.1.2	C0 to C132	7.16.4	HV-gen command page
6.1.3	V _{SS1} and V _{SS2}	7.16.5	Special feature command page
6.1.4	V _{DD1} to V _{DD3}	7.16.6	Instruction set
6.1.5	V _{LCDOUT}	7.17	I ² C-bus interface
6.1.6	V _{LCDIN}	7.17.1	Characteristics of the I ² C-bus
6.1.7	V _{LCDSENSE}	7.17.2	I ² C-bus protocol
6.1.8	SDA	8	LIMITING VALUES (PROVISIONAL)
6.1.9	SDAOUT	9	HANDLING
6.1.10	SCL	10	DC CHARACTERISTICS
6.1.11	SA0 and SA1	11	AC CHARACTERISTICS
6.1.12	OSC	12	RESET TIMING
6.1.13	RES	13	APPLICATION INFORMATION
6.1.14	T1, T2, T3, T4 and T5	14	BONDING PAD LOCATIONS
7	FUNCTIONAL DESCRIPTION	15	DEVICE PROTECTION DIAGRAM
7.1	Reset	16	TRAY INFORMATION
7.2	Power-down	17	DEFINITIONS
7.3	LCD voltage selector	18	LIFE SUPPORT APPLICATIONS
7.4	Oscillator	19	PURCHASE OF PHILIPS I ² C COMPONENTS
7.5	Timing	20	BARE DIE DISCLAIMER
7.6	Column driver outputs		
7.7	Row driver outputs		
7.8	Drive waveforms		
7.9	Set multiplex rate		

65 × 133 pixel matrix driver

PCF8535

1 FEATURES

- Single-chip LCD controller/driver
- 65 row, 133 column outputs
- Display data RAM 65 × 133 bits
- 133 icons (last row is used for icons)
- Fast mode I²C-bus interface (400 kbits/s)
- Software selectable multiplex rates:
1 : 17, 1 : 26, 1 : 34, 1 : 49 and 1 : 65
- On-chip:
 - Generation of intermediate LCD bias voltages
 - Oscillator requires no external components (external clock also possible)
 - Generation of V_{LCD}.
- CMOS compatible inputs
- Software selectable bias configuration
- Logic supply voltage range V_{DD1} to V_{SS1} 4.5 to 5.5 V
- Supply voltage range for high voltage part V_{DD2} and V_{DD3} to V_{SS2} and V_{SS3} 4.5 to 5.5 V
- Display supply voltage range V_{LCD} to V_{SS}:
 - Mux rate 1 : 65: 8 to 16 V.
- Low power consumption, suitable for battery operated systems
- Internal Power-on reset and/or external reset
- Temperature read back available
- Manufactured in N-well silicon gate CMOS process.

**2 APPLICATIONS**

- Automotive information systems
- Telecommunication systems
- Point-of-sale terminals
- Instrumentation.

3 GENERAL DESCRIPTION

The PCF8535 is a low power CMOS LCD row/column driver, designed to drive dot matrix graphic displays at multiplex rates of 1 : 17, 1 : 26, 1 : 34, 1 : 49 and 1 : 65. Furthermore, it can drive up to 133 icons. All necessary functions for the display are provided in a single chip, including on-chip generation of LCD bias voltages, resulting in a minimum of external components and low power consumption. The PCF8535 is compatible with most microcontrollers and communicates via an industry standard two-line bidirectional I²C-bus serial interface. All inputs are CMOS compatible.

4 ORDERING INFORMATION

TYPE NUMBER	PACKAGE		
	NAME	DESCRIPTION	VERSION
PCF8535U	–	chip with bumps in tray	–

65 × 133 pixel matrix driver

PCF8535

5 BLOCK DIAGRAM

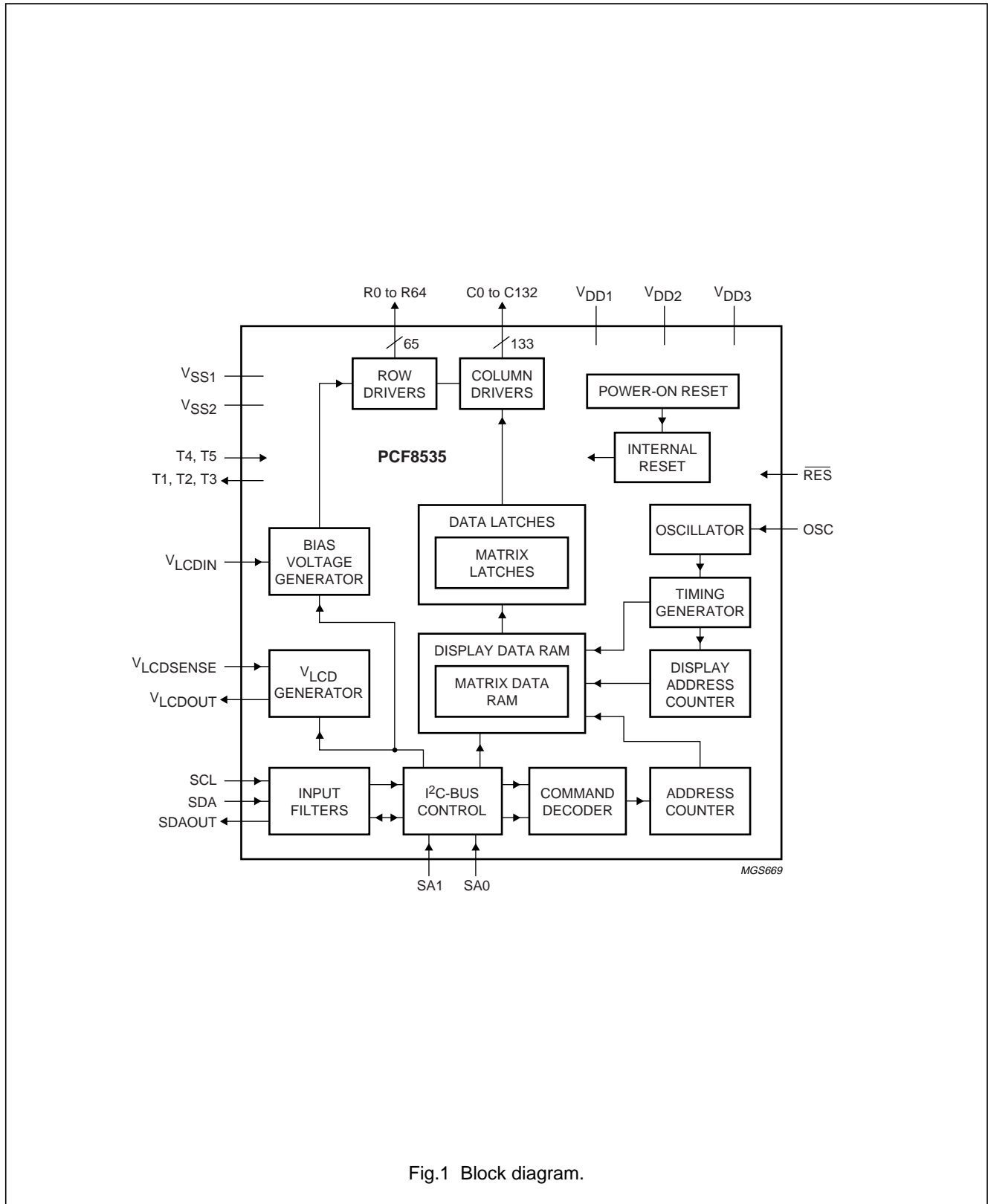

Fig.1 Block diagram.

65 × 133 pixel matrix driver**PCF8535**

5.1 Block diagram functions**5.1.1 OSCILLATOR**

The on-chip oscillator provides the display clock for the system; it requires no external components. Alternatively, an external display clock may be provided via the OSC input. The OSC input must be connected to V_{DD1} or V_{SS1} when not in use. During power-down additional current saving can be made if the external clock is disabled.

5.1.2 POWER-ON RESET

The on-chip Power-on reset initializes the chip after power-on or power failure.

5.1.3 I²C-BUS CONTROLLER

The I²C-bus controller detects the I²C-bus protocol, slave address, commands and display data bytes. It performs the conversion of the data input (serial-to-parallel). The PCF8535 acts as an I²C-bus slave and therefore cannot initiate bus communication.

5.1.4 INPUT FILTERS

Input filters are provided to enhance noise immunity in electrically adverse environments; RC low-pass filters are provided on the SDA, SCL and RES lines.

5.1.5 DISPLAY DATA RAM

The PCF8535 contains a 65 × 133 bit static RAM which stores the display data. The RAM is divided into 9 banks of 133 bytes. The last bank is used for icon data and is only one bit deep. During RAM access, data is transferred to the RAM via the I²C-bus interface. There is a direct correspondence between the X address and the column output number.

5.1.6 TIMING GENERATOR

The timing generator produces the various signals required to drive the internal circuitry. Internal chip operation is not disturbed by operations on the data bus.

5.1.7 ADDRESS COUNTER

The Address Counter (AC) sends addresses to the Display Data RAM (DDRAM) for writing.

5.1.8 DISPLAY ADDRESS COUNTER

The display is generated by continuously shifting rows of RAM data to the dot matrix LCD via the column outputs. The display status (all dots on or off, normal or inverse video) is set via the I²C-bus.

65 × 133 pixel matrix driver

PCF8535

6 PINNING

SYMBOL	PAD	DESCRIPTION
	1	dummy pad
	2	bump/alignment mark 1
R0 to R15	3 to 18	LCD row driver outputs
C0 to C132	19 to 151	LCD column driver outputs
R47 to R33	152 to 166	LCD row driver outputs
	167	bump/alignment mark 2
	168	dummy pad
R48 to R64	169 to 185	LCD row driver outputs; R64 is icon row
	186	bump/alignment mark 3
	187 to 189	dummy pad
OSC	190	oscillator
V _{LCDIN}	191 to 196	LCD supply voltage
V _{LCDOUT}	197 to 203	voltage multiplier output
V _{LCDSENSE}	204	voltage multiplier regulation input (V _{LCD})
	205 and 206	dummy pad
RES	207	external reset input (active LOW)
T3	208	test output 3
T2	209	test output 2
T1	210	test output 1
V _{DD2}	211 to 218	supply voltage 2
V _{DD3}	219 to 222	supply voltage 3
V _{DD1}	223 to 228	supply voltage 1
	229	dummy pad
SDA	230 and 231	I ² C-bus serial data inputs
SDAOUT	232	I ² C-bus serial data output
SA1	233	I ² C-bus slave address input
SA0	234	I ² C-bus slave address input
V _{SS2}	235 to 242	ground 2
V _{SS1}	243 to 250	ground 1
T5	251	test input 5
T4	252	test input 4
	253	dummy pad
SCL	254 and 255	I ² C-bus serial clock inputs
	256	bump/alignment mark 4
R32 to R16	257 to 273	LCD row driver outputs

6.1 Pin functions

6.1.1 R0 TO R64

These pads output the display row signals.

65 × 133 pixel matrix driver

PCF8535

6.1.2 C0 TO C132

These pads output the display column signals.

6.1.3 V_{SS1} AND V_{SS2}

V_{SS1} and V_{SS2} must be connected together.

6.1.4 V_{DD1} TO V_{DD3}

V_{DD1} is the logic supply. V_{DD2} and V_{DD3} are for the voltage multiplier. For split power supplies V_{DD2} and V_{DD3} must be connected together. If only one supply voltage is available, all three supplies must be connected together.

6.1.5 V_{LCDOUT}

If, in the application, an external V_{LCD} is used, V_{LCDOUT} must be left open-circuit; otherwise (if the internal voltage multiplier is enabled) the chip may be damaged. V_{LCDOUT} should not be driven when V_{DD1} is below its minimum allowed value otherwise a low impedance path between V_{LCDOUT} and V_{SS1} will exist.

6.1.6 V_{LCDIN}

This is the V_{LCD} supply for when an external V_{LCD} is used. If the internal V_{LCD} generator is used, then V_{LCDOUT} and V_{LCDIN} must be connected together. V_{LCDIN} should not be driven when V_{DD1} is below its minimum allowed value, otherwise a low impedance path between V_{LCDIN} and V_{SS1} will exist.

6.1.7 V_{LCDSENSE}

This is the input to the internal voltage multiplier regulator. It must be connected to V_{LCDOUT} when the internal voltage generator is used otherwise it may be left open-circuit. V_{LCDSENSE} should not be driven when V_{DD1} is below its minimum allowed value, otherwise a low impedance path between V_{LCDSENSE} and V_{SS1} will exist.

6.1.8 SDA

I²C-bus serial data input.

6.1.9 SDAOUT

SDAOUT is the serial data acknowledge for the I²C-bus. By connecting SDAOUT to SDA externally, the SDA line becomes fully I²C-bus compatible. Having the acknowledge output separated from the serial data line is advantageous in Chip-On-Glass (COG) applications. In COG applications where the track resistance from the SDAOUT pad to the system SDA line can be significant, a potential divider is generated by the bus pull-up resistor

and the Indium Tin Oxide (ITO) track resistance. It is possible that during the acknowledge cycle the PCF8535 will not be able to create a valid logic 0 level. By splitting the SDA input from the SDAOUT output the device could be used in a mode that ignores the acknowledge bit. In COG applications where the acknowledge cycle is required or where read back is required, it is necessary to minimize the track resistance from the SDAOUT pad to the system SDA line to guarantee a valid LOW level.

6.1.10 SCL

I²C-bus serial clock input.

6.1.11 SA0 AND SA1

Least significant bits of the I²C-bus slave address.

Table 1 Slave address; see note 1

SA1 AND SA0	MODE	SLAVE ADDRESS
0 and 0	write	78H
	read	79H
0 and 1	write	7AH
	read	7BH
1 and 0	write	7CH
	read	7DH
1 and 1	write	7EH
	read	7FH

Note

- The slave address is a concatenation of the following bits {01111, SA1, SA0 and R/W}.

6.1.12 OSC

If the on-chip oscillator is used this input must be connected to V_{DD1} or V_{SS1}.

6.1.13 $\overline{\text{RES}}$

External reset pad: when this pad is LOW the chip will be reset; see Section 7.1. If an external reset is not required, this pad must be tied to V_{DD1}. Timing for the $\overline{\text{RES}}$ pad is given in Chapter 12.

6.1.14 T1, T2, T3, T4 AND T5

In applications T4 and T5 must be connected to V_{SS}. T1, T2 and T3 are to be left open-circuit.

65 × 133 pixel matrix driver

PCF8535

7 FUNCTIONAL DESCRIPTION

The PCF8535 is a low power LCD driver designed to interface with microprocessors/microcontrollers and a wide variety of LCDs.

The host microprocessor/microcontroller and the PCF8535 are both connected to the I²C-bus. The SDA and SCL lines must be connected to the positive power supply via pull-up resistors. The internal oscillator requires no external components. The appropriate intermediate biasing voltage for the multiplexed LCD waveforms are generated on-chip. The only other connections required to complete the system are to the power supplies (V_{DD}, V_{SS} and V_{LCD}) and suitable capacitors for decoupling V_{LCD} and V_{DD}.

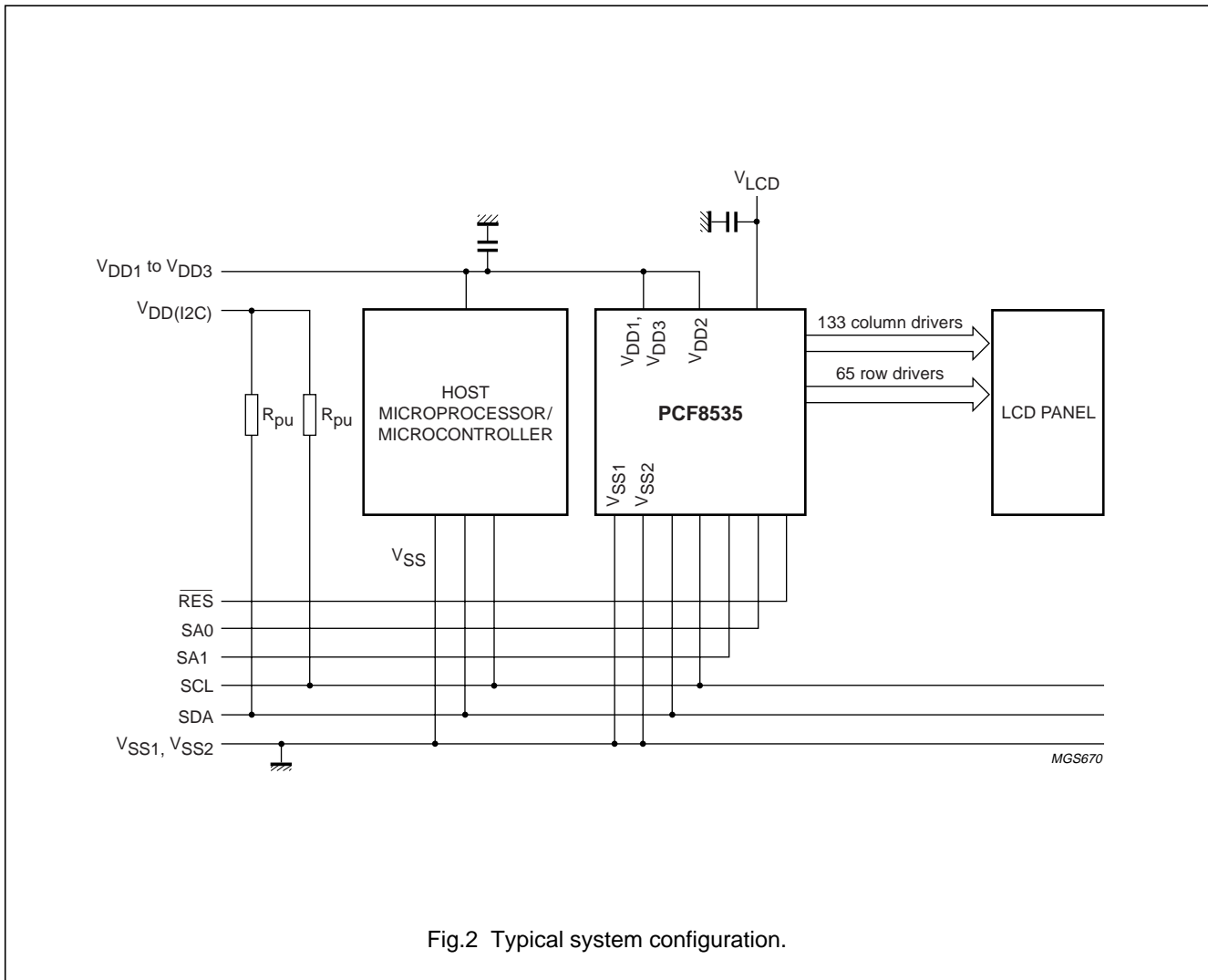

Fig.2 Typical system configuration.

65 × 133 pixel matrix driver

PCF8535

7.1 Reset

The PCF8535 has two reset modes; internal Power-on reset or external reset. Reset initiated from either the $\overline{\text{RES}}$ pad or the internal Power-on reset block will initialize the chip to the following starting condition:

- Power-down mode (PD = 1)
- Horizontal addressing (V = 0); no mirror X or Y (MX = 0 and MY = 0)
- Display blank (D = 0 and E = 0)
- Address counter X[6:0] = 0, Y[2:0] = 0 and XM₀ = 0
- Bias system BS[2:0] = 0
- Multiplex rate M[2:0] = 0 (Mux rate 1 : 17)
- Temperature control mode TC[2:0] = 0
- HV-gen control, HVE = 0 the HV generator is switched off, PRS = 0 and S[1:0] = 00
- V_{LCDOUT} is equal to 0 V
- RAM data is unchanged (Note: RAM data is undefined after power-up)
- All row and column outputs are set to V_{SS} (display off)
- TRS and BRS are set to zero
- Direct mode is disabled (DM = 0)
- Internal oscillator is selected, but not running (EC = 0)
- Bias current set to low current mode (IB = 0).

7.2 Power-down

During power-down all static currents are switched off (no internal oscillator, no timing and no LCD segment drive system) and all LCD outputs are internally connected to V_{SS}. The serial bus function remains active.

7.3 LCD voltage selector

The practical value for V_{OP} is determined by equating V_{off(rms)} with defined LCD threshold voltage (V_{th}), typically when the LCD exhibits approximately 10% contrast.

7.4 Oscillator

The internal logic operation and the multi-level drive signals of the PCF8535 are clocked by the built-in RC oscillator. No external components are required.

7.5 Timing

The timing of the PCF8535 organizes the internal data flow of the device. The timing also generates the LCD frame frequency which is derived from the clock frequency generated in the internal clock generator.

7.6 Column driver outputs

The LCD drive section includes 133 column outputs (C0 to C132) which should be connected directly to the LCD. The column output signals are generated in accordance with the multiplexed row signals and with the data in the display latch. When less than 133 columns are required the unused column outputs should be left open-circuit.

7.7 Row driver outputs

The LCD drive section includes 65 row outputs (R0 to R64) which should be connected directly to the LCD. The row output signals are generated in accordance with the selected LCD drive mode. If lower Mux rates or less than 65 rows are required, the unused outputs should be left open-circuit.

65 × 133 pixel matrix driver

PCF8535

7.8 Drive waveforms

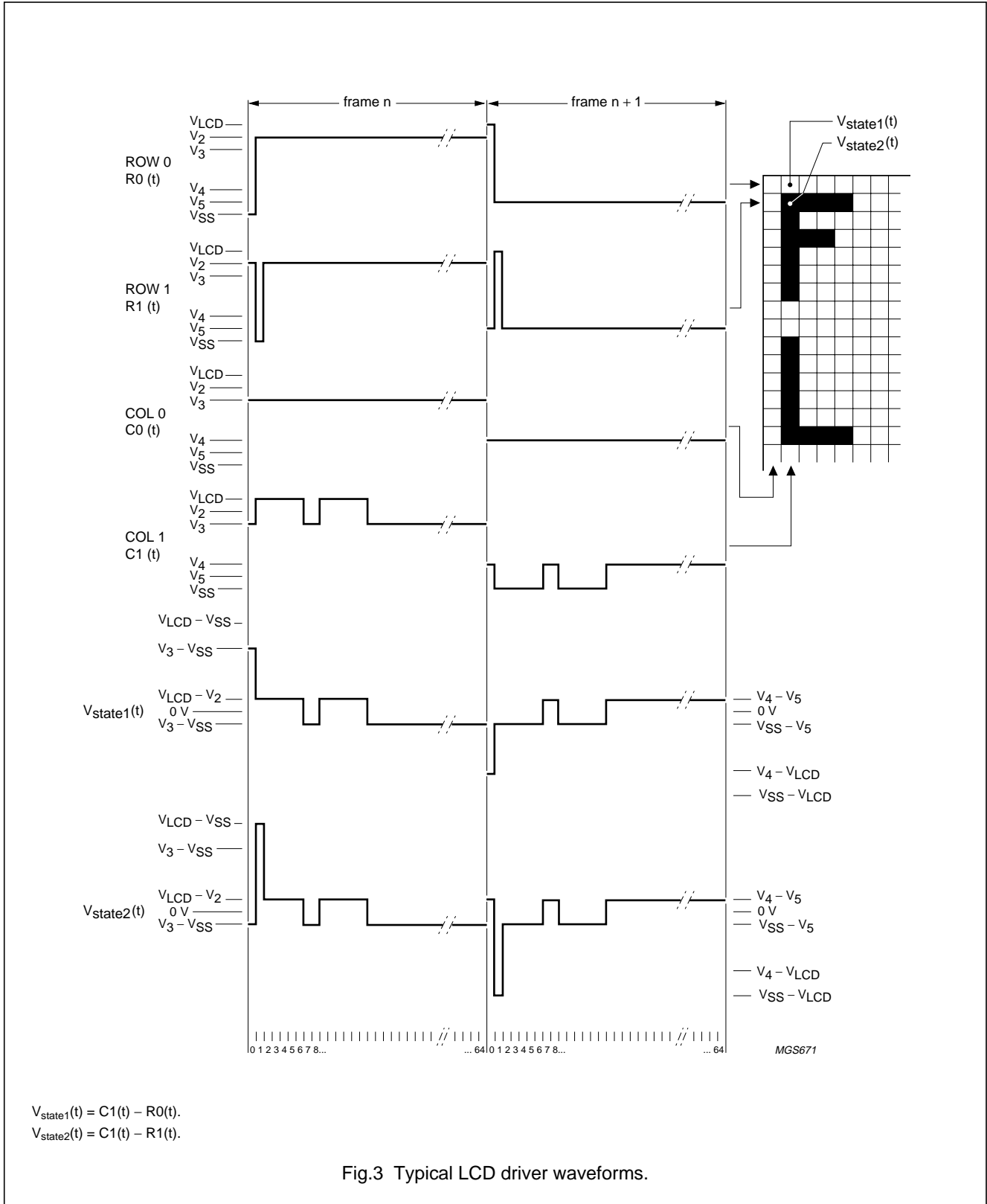

Fig.3 Typical LCD driver waveforms.

65 × 133 pixel matrix driver

PCF8535

7.9 Set multiplex rate

The PCF8535 can be used to drive displays of varying sizes. The multiplex mode selected controls which rows are used. In all cases, the last row is always driven and is intended for icons. If Top Row Swap (TRS) is at logic 1 then the icon row will be output on pad R48. M[2:0] selects the multiplex rate (see Table 2).

Table 2 Multiplex rates

M[2]	M[1]	M[0]	MULTIPLEX RATE	ACTIVE ROWS
0	0	0	1 : 17	R0 to R15 and R64
0	0	1	1 : 26	R0 to R24 and R64
0	1	0	1 : 34	R0 to R32 and R64
0	1	1	1 : 49	R0 to R47 and R64
1	0	0	1 : 65	R0 to R64
101 – 111			do not use	–

7.10 Bias system

7.10.1 SET BIAS SYSTEM

The bias voltage levels are set in the ratio of R – R – nR – R – R. Different multiplex rates require different factors n. This is programmed by BS[2:0]. For optimum bias values, n can be calculated from: $n = \sqrt{\text{Mux rate}} - 3$

Changing the bias system from the optimum will have a consequence on the contrast and viewing angle. One reason to come away from the optimum would be to reduce the required V_{OP} . A compromise between contrast and V_{OP} must be found for any particular application.

Table 3 Programming the required bias system

BS[2]	BS[1]	BS[0]	n	BIAS MODE	TYPICAL MUX RATES
0	0	0	7	$1/11$	1 : 100
0	0	1	6	$1/10$	1 : 80
0	1	0	5	$1/9$	1 : 65
0	1	1	4	$1/8$	1 : 49
1	0	0	3	$1/7$	1 : 33
1	0	1	2	$1/6$	1 : 26
1	1	0	1	$1/5$	1 : 17
1	1	1	0	$1/4$	1 : 9

65 × 133 pixel matrix driver

PCF8535

Table 4 Example of LCD bias voltage for 1/7bias, n = 3

SYMBOL	BIAS VOLTAGE FOR 1/7BIAS
V1	V _{LCD}
V2	6/7 × V _{LCD}
V3	5/7 × V _{LCD}
V4	2/7 × V _{LCD}
V5	1/7 × V _{LCD}
V6	V _{SS}

7.11 Temperature measurement

7.11.1 TEMPERATURE READ BACK

The PCF8535 has an in-built temperature sensor. For power saving, the sensor should only be enabled when a measurement is required. It will not operate in power-down mode. The temperature read back requires a clock to operate. Normally the internal clock is used but, if the device is operating from an external clock, then this must be present for the measurement to work. V_{DD2} and V_{DD3} must also be applied. A measurement is initialized by setting the SM bit. Once started the SM bit will be automatically cleared. An internal oscillator will be initialized and allowed to warm-up for approximately 2 frame periods. After this the measurement starts and lasts for a maximum of 2 frame periods.

Temperature data is returned via a status register. During the measurement the register will contain zero. Once the measurement is completed the register will be updated with the current temperature (non zero value). Because the I²C-bus interface is asynchronous to the temperature measurement, read back prior to the end of the measurement is not guaranteed. If this mode is required the register should be read twice to validate the data.

The ideal temperature read-out can be calculated as follows;

$$TR_{ideal} = 128 + (T - 27 \text{ °C}) \times \frac{1}{c} \tag{1}$$

where T is the on-chip temperature in °C and c is the conversion constant; c = 1.17 °C/lb.

To improve the accuracy of the temperature measurement a calibration is recommended during the assembly of the final product.

For calibrating the temperature read-out a measurement must be taken at a defined temperature. The offset between the ideal read-out and the actual result has to be stored into a non-volatile register (e.g. EEPROM);

$$Offset = TR_{ideal} - TR_{meas} \tag{2}$$

where TR_{meas} is the actual temperature read-out of the PCF8535.

The calibrated temperature read-out can be calculated for each measurement as follows:

$$TR_{cal} = TR_{meas} + Offset \tag{3}$$

The accuracy after the calibration is ±6.7% (plus ±1 lsb) of the difference between the current temperature and the calibration temperature. For this reason a calibration at or near the most sensitive temperature for the display is recommended.

E.g. for a calibration at 25 °C with the current temperature at -20 °C, the absolute error may be calculated as:

$$Absolute\ error = 0.067 \times (25 \text{ °C} - -20 \text{ °C}) = \pm 3 \text{ °C} + \pm 1 \text{ lsb} = \pm 4.17 \text{ °C}$$

7.12 Temperature compensation

7.12.1 TEMPERATURE COEFFICIENTS

Due to the temperature dependency of the liquid crystals viscosity the LCD controlling voltage, V must be increased at lower temperatures to maintain optimum contrast. Figure 4 shows V_{LCD} as a function of temperature for a typical high multiplex rate liquid.

In the PCF8535 the temperature coefficient of V_{LCD} can be selected from 8 values by setting bits TC[2:0], see Table 5.

65 × 133 pixel matrix driver

PCF8535

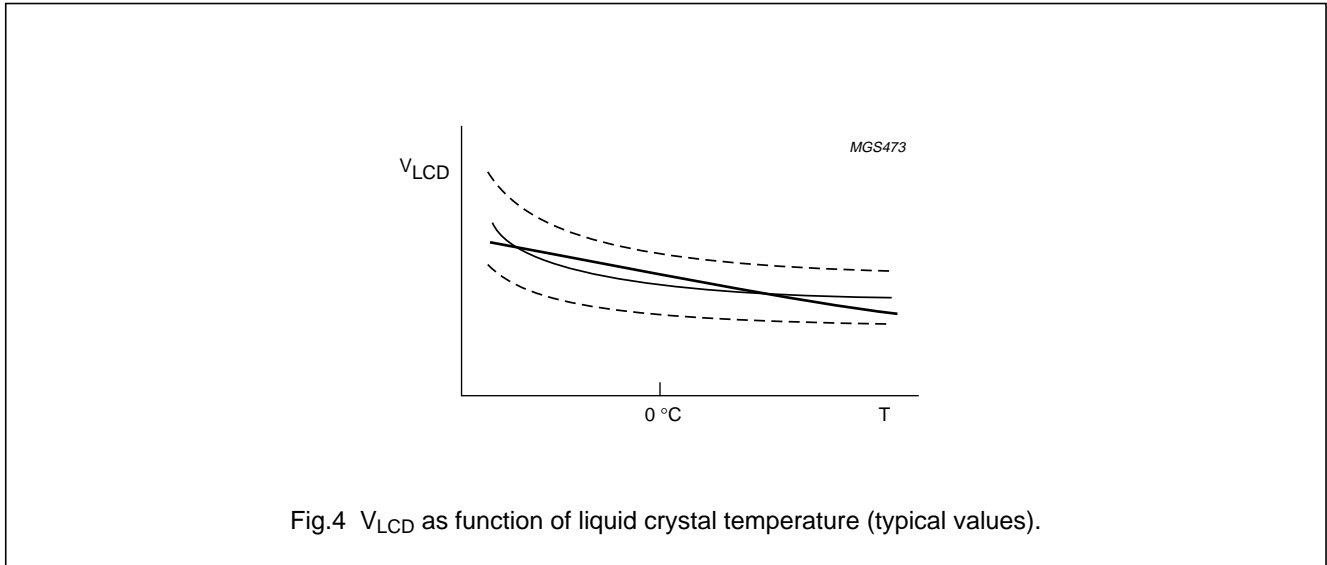

Fig.4 V_{LCD} as function of liquid crystal temperature (typical values).

Table 5 Selectable temperature coefficients

TC[2]	TC[1]	TC[0]	TC VALUE	UNIT
0	0	0	0	1/°C
0	0	1	-0.44 × 10 ⁻³	1/°C
0	1	0	-1.10 × 10 ⁻³	1/°C
0	1	1	-1.45 × 10 ⁻³	1/°C
1	0	0	-1.91 × 10 ⁻³	1/°C
1	0	1	-2.15 × 10 ⁻³	1/°C
1	1	0	-2.32 × 10 ⁻³	1/°C
1	1	1	-2.74 × 10 ⁻³	1/°C

7.13 V_{OP}

7.13.1 SET V_{OP} VALUE

The voltage at the reference temperature can be calculated as: [V_{LCD} (T = T_{cut})]

$$V_{LCD(T_{cut})} = (a + V_{OP} \times b) \tag{4}$$

The operating voltage, V_{OP}, can be set by software. The generated voltage is dependent on the temperature, programmed Temperature Coefficient (TC) and the programmed voltage at the reference temperature (T_{cut}):

$$V_{LCD} = (a + V_{OP} \times b) \times (1 + ((T - T_{cut}) \times TC)) \tag{5}$$

The values for T_{cut}, a and b are given in Table 6. The maximum voltage that can be generated is dependent on the voltage V_{DD2} and the display load current. Two overlapping V_{OP} ranges are selectable via the command page “Hv-gen control”, see Fig.5.

The low range offers programming from 4.5 to 10.215 V, with the high range from 10.215 to 15.93 V at the cut point temperature, T_{cut}. Care must be taken, when using temperature coefficients, that the programmed voltage does not exceed the maximum allowed V_{LCD} voltage, see Chapter 10.

For a particular liquid, the optimum V_{LCD} can be calculated for a given multiplex rate. For a Mux rate of 1 : 65, the optimum operating voltage of the liquid can be calculated as:

$$V_{LCD} = \frac{1 + \sqrt{65}}{\sqrt{2 \times \left(1 - \frac{1}{\sqrt{65}}\right)}} \times V_{th} = 6.85 \times V_{th} \tag{6}$$

where V_{th} is the threshold voltage of the liquid crystal material used.

Table 6 Values for parameters of the HV generator programming

SYMBOL	BITS	VALUE	UNIT
a	PRS = 0	4.5	V
	PRS = 1	10.215	V
b		0.045	V
T _{cut}		27	°C

65 × 133 pixel matrix driver

PCF8535

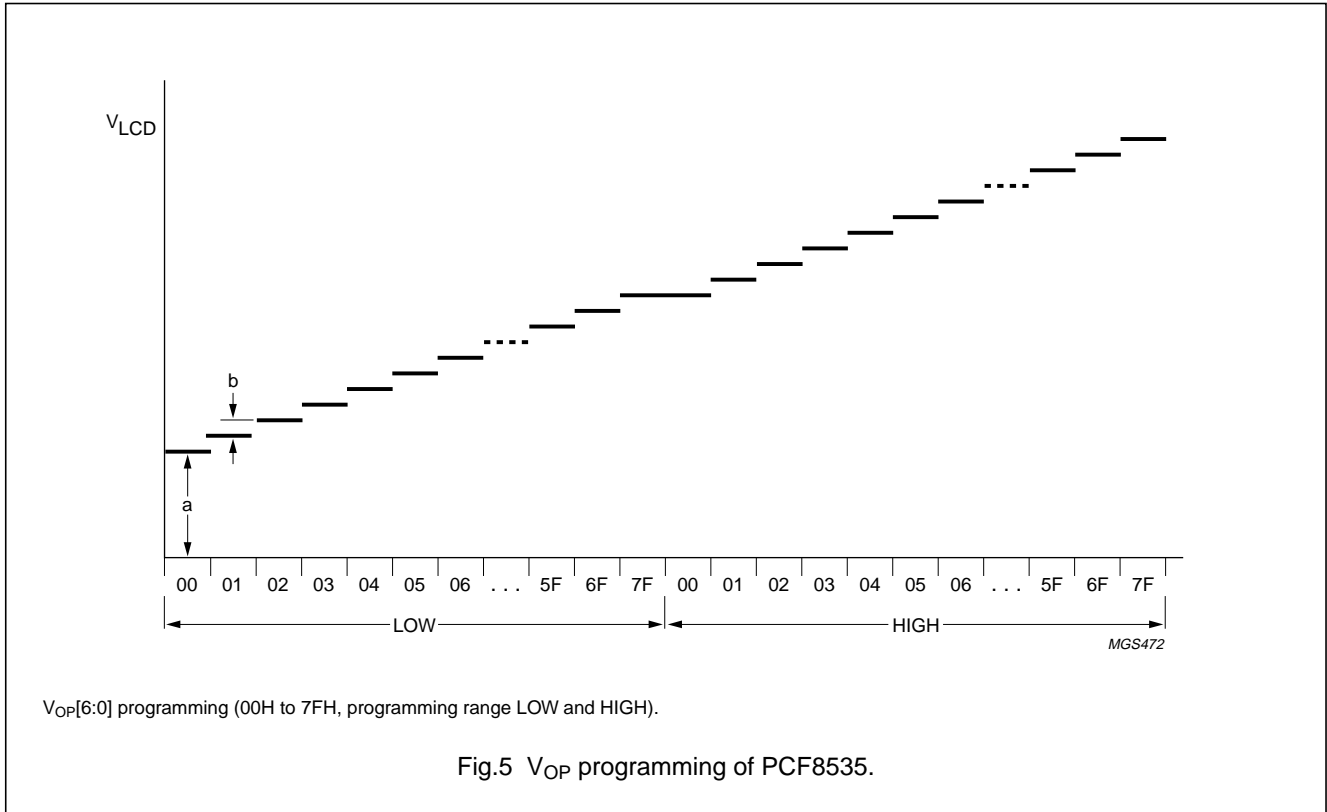

7.14 Voltage multiplier control

7.14.1 S[1:0]

The PCF8535 incorporates a software configurable voltage multiplier. After reset (\overline{RES}) the voltage multiplier is set to $2 \times V_{DD2}$. Other voltage multiplier factors are set via the HV-gen command page. Before switching on the charge pump, the charge pump has to be pre-charged using the following sequence.

A starting state of HVE = 0, DOF = 0, PD = 1 and DM = 0 is assumed. A small delay between steps is indicated. The recommended wait period is 20 μ s per 100 nF of capacitance on V_{LCD1}.

1. Set DM = 1 and PD = 0
2. Delay
3. Set the multiplication factor to 2 by setting S[1:0] = 00
4. Set the required V_{OP} and PRS.
5. Set HVE = 1 to switch-on the charge pump with a multiplication factor of 2
6. Delay
7. Increase the number of stages, one at a time, with a delay between each until the required level is achieved.

Table 7 HV generator multiplication factor

S[1]	S[0]	MULTIPLICATION FACTOR
0	0	$2 \times V_{DD2}$
0	1	$3 \times V_{DD2}$
1	0	$4 \times V_{DD2}$
1	1	$5 \times V_{DD2}$

65 × 133 pixel matrix driver

PCF8535

7.15 Addressing

Addressing of the RAM can be split into two parts; input addressing and output addressing. Input addressing is concerned with writing data into the RAM. Output addressing is almost entirely automatic and taken care of by the device, however, it is possible to affect the output mode.

The display RAM has a matrix of 65 × 133 bits. The columns are addressed by a combination of the X address pointer and the X-RAM page pointer, whilst the rows addressed in groups of 8 by the Y address pointer. The X address pointer has a range of 0 to 127 (7FH). Its range can be extended by the X-RAM page pointer, XM₀. The Y address pointer has a range of 0 to 8 (08H). The PCF8535 is limited to 133 columns by 65 rows, addressing the RAM outside of this area is not allowed.

7.15.1 INPUT ADDRESSING

Data is down loaded byte wise into the RAM matrix of the PCF8535 as indicated in Figs 6 to 10.

Table 8 Effect of X-RAM page pointer

X ADDRESS POINTER	X-RAM PAGE POINTER XM ₀	ADDRESSED COLUMN MX = 0	ADDRESSED COLUMN MX = 1
0	0	C0	C132
1	0	C1	C131
2	0	C2	C130
:	:	:	:
125	0	C125	C7
126	0	C126	C6
127	0	C127	C5
0	1	C128	C4
1	1	C129	C3
:	:	:	:
4	1	C132	C0

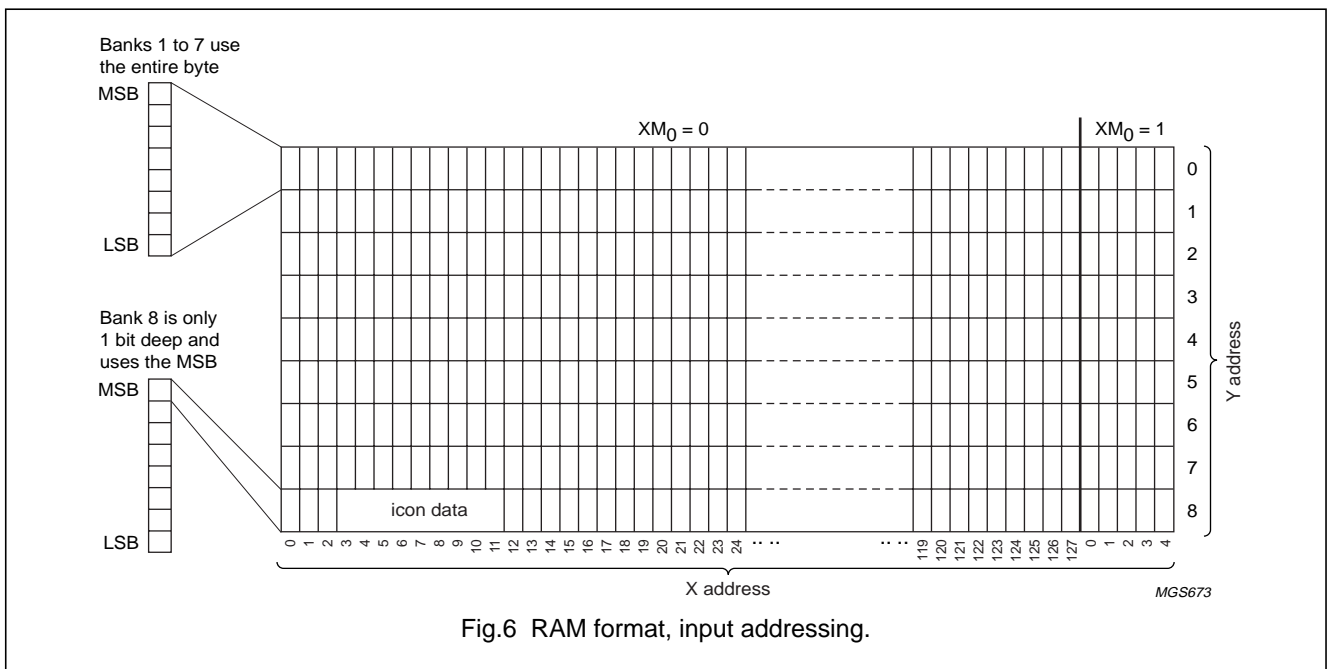

Fig.6 RAM format, input addressing.

65 × 133 pixel matrix driver

PCF8535

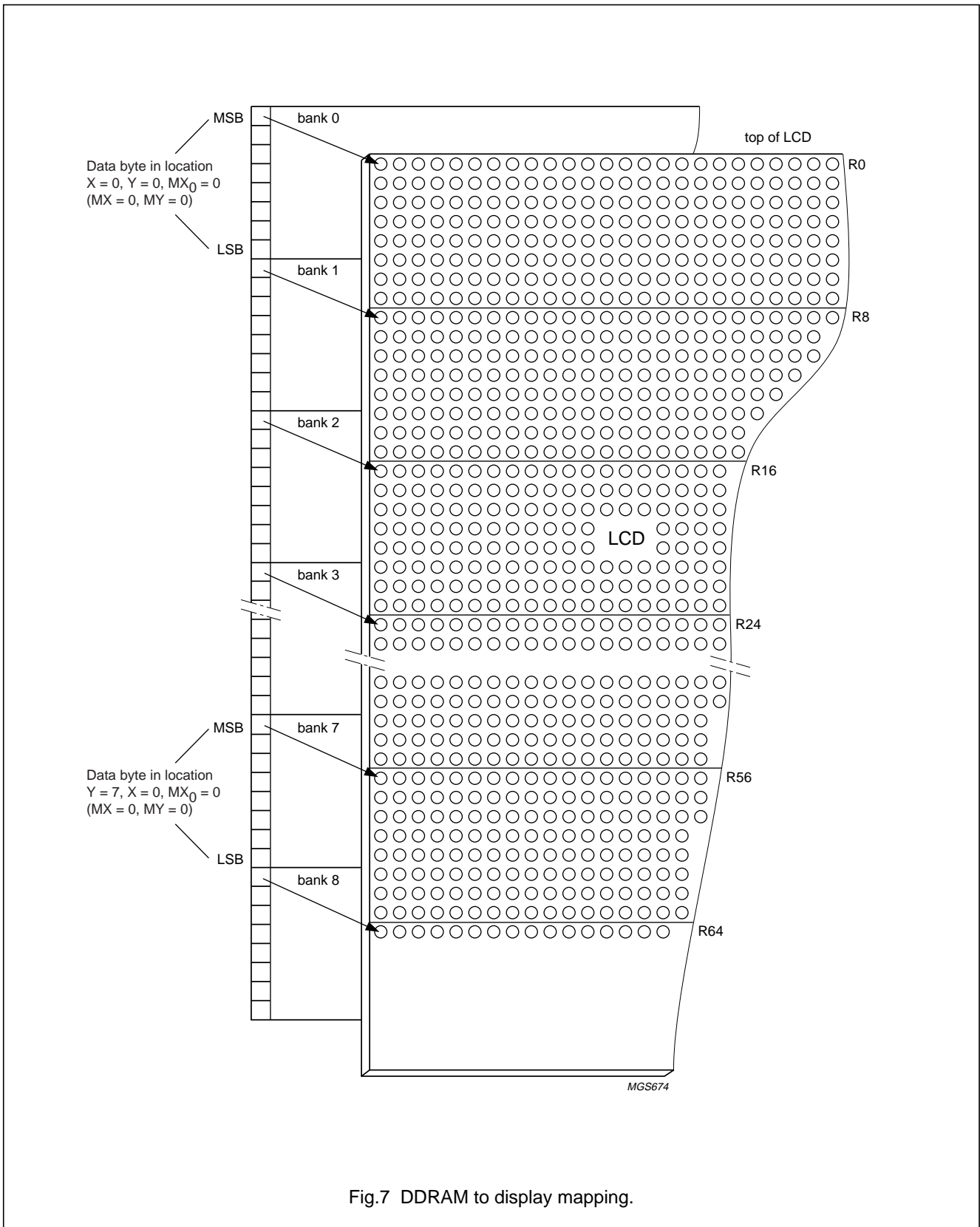

Fig.7 DDRAM to display mapping.

65 × 133 pixel matrix driver

PCF8535

Two automated addressing modes are available; vertical addressing ($V = 1$) and horizontal addressing ($V = 0$). These modes change the way in which the auto-incrementing of the address pointers is handled and are independent of multiplex rate. The auto-incrementing works in a way so as to aid filling of the entire RAM. It is not a prerequisite of operation that the entire RAM is filled; in lower multiplex modes not all of the RAM will be needed. For these multiplex rates, use of horizontal addressing mode ($V = 0$) is recommended.

Addressing the icon row is a special case as these RAM locations are not automatically accessed. These locations must be explicitly addressed by setting the Y address pointer to 8.

The Y address pointer does not auto-increment when the X address over or underflows, it stays set to 8. Writing icon data is independent of the vertical and horizontal addressing mode, but is effected by the mirror X bit as described in Sections 7.15.1.2 and 7.15.1.3.

The addressing modes may be further modified by the mirror X bit MX. This bit causes the data to be written into the RAM from right to left instead of the normal left to right. This effectively flips the display about the Y axis. The MX bit affects the mode of writing into the RAM, changing the MX bit after RAM data is written will not flip the display.

7.15.1.1 Vertical addressing: non-mirrored; $V = 1$ and $MX = 0$

In the vertical addressing mode data is written top to bottom and left to right. Here, the Y counter will auto-increment from 0 to 7 and then wrap around to 0 (see Fig.8). On each wrap over, the X counter will increment to address the next column. When the X counter wraps over from 127 to 0, the XM_0 bit will be set. The last address accessible is $Y = 7, X = 4$ and $XM_0 = 1$; after this access the counter will wrap around to $Y = 0, X = 0$ and $XM_0 = 0$.

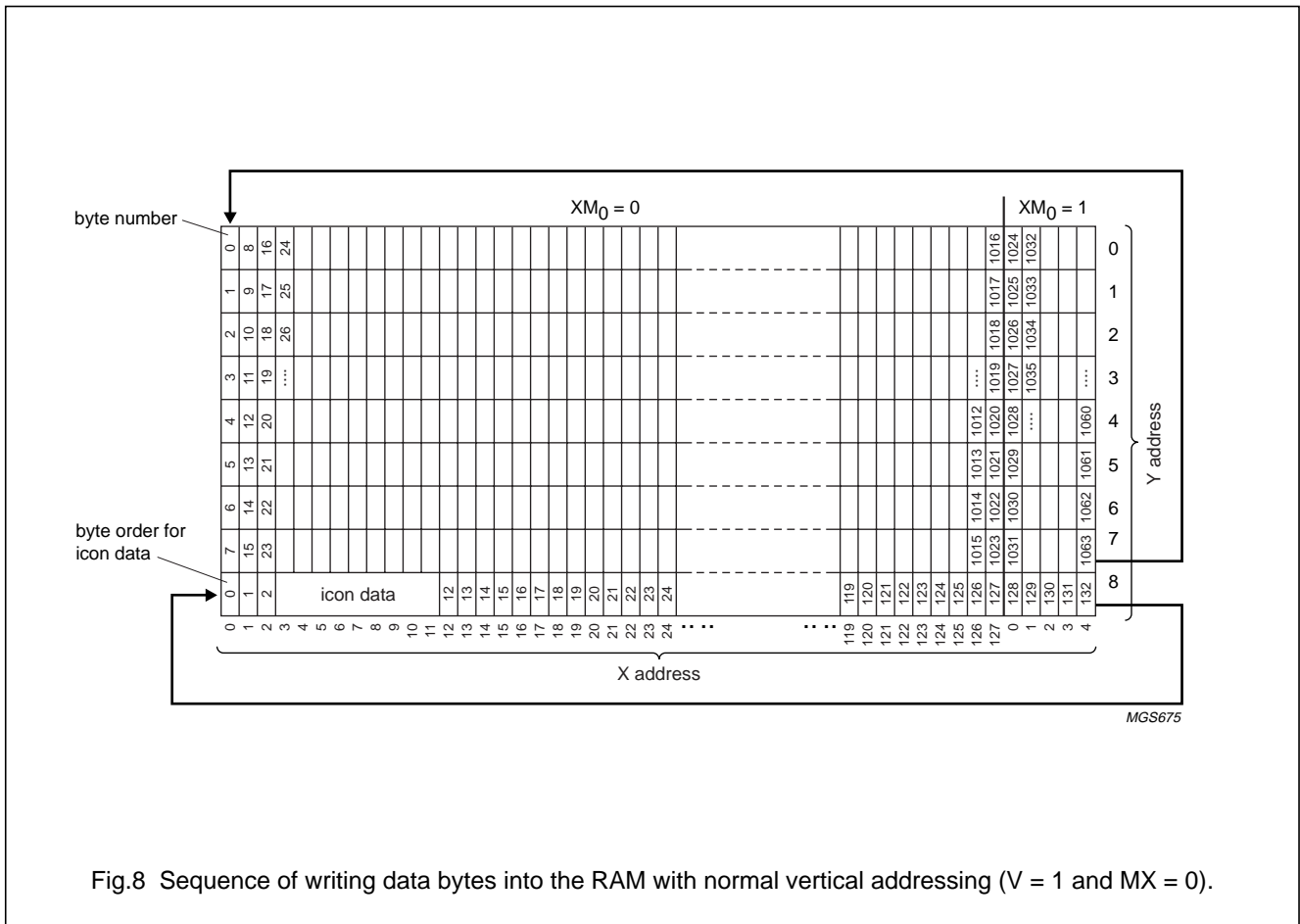

Fig.8 Sequence of writing data bytes into the RAM with normal vertical addressing ($V = 1$ and $MX = 0$).

65 × 133 pixel matrix driver

PCF8535

7.15.1.2 Vertical addressing: mirrored; V = 1 and MX = 1

It is also possible to write data from right to left, instead of from the normal left to right, still going top to bottom. In the mirrored vertical addressing mode the Y counter will auto-increment from 0 to 7 and then wrap around to 0 (see Fig.9). On each wrap-over, the X counter will decrement to address the preceding column. The XM₀ bit will be automatically toggled each time the X address counter wraps over from 0. The last address accessible is Y = 7, X = 0 and XM₀ = 0; after this access the counter will wrap around to Y = 0, X = 4 and XM₀ = 1.

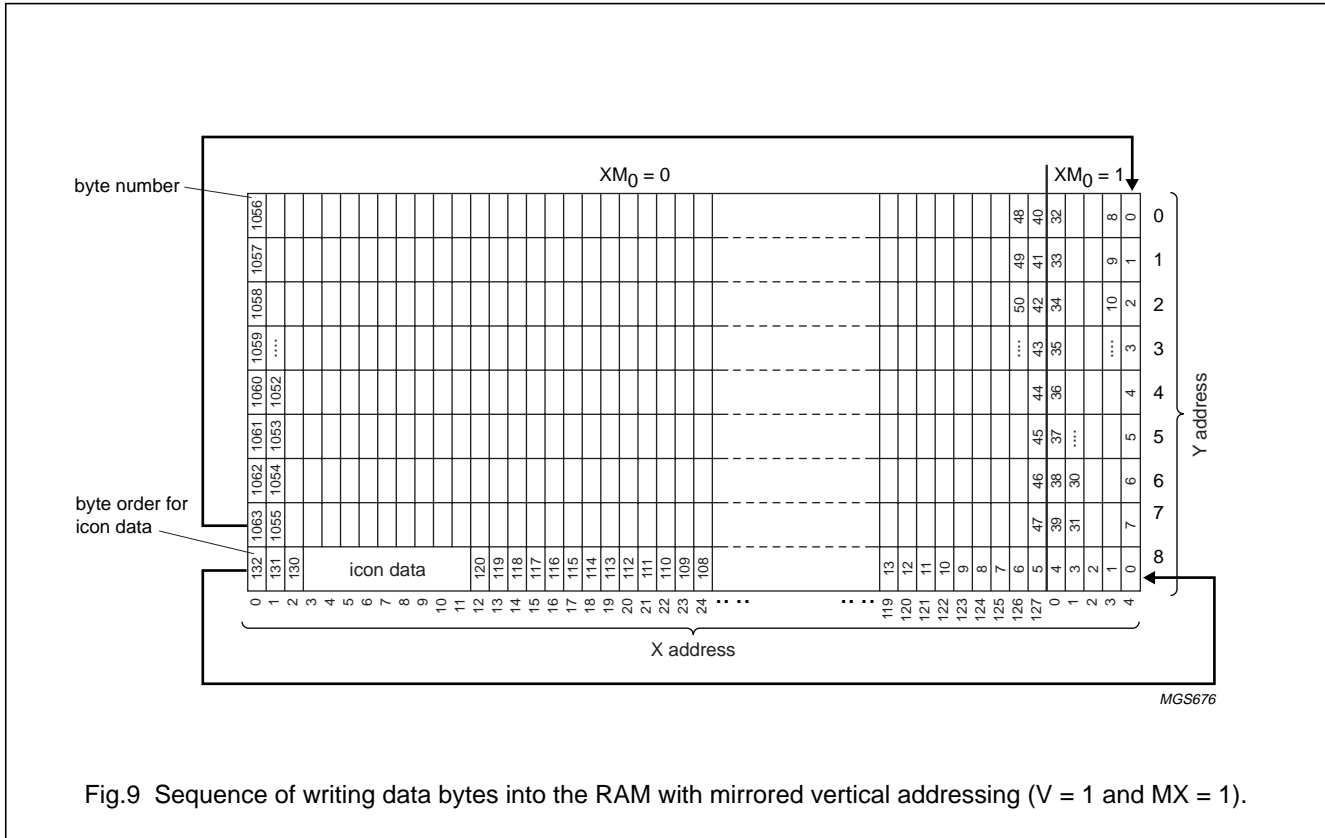

Fig.9 Sequence of writing data bytes into the RAM with mirrored vertical addressing (V = 1 and MX = 1).

65 × 133 pixel matrix driver

PCF8535

7.15.1.3 Horizontal addressing: non-mirrored; V = 0 and MX = 0

In horizontal addressing mode data is written from left to right and top to bottom. Here, the X counter will auto-increment from 0 to 127, set the XM₀, then count 0 to 4 before wrapping around to 0 and clearing the XM₀ bit (see Fig.10). On each wrap-over, the Y counter will increment. The last address accessible is Y = 7, X = 4 and XM₀ = 1; after this access the counter will wrap around to Y = 0, X = 0 and XM₀ = 0.

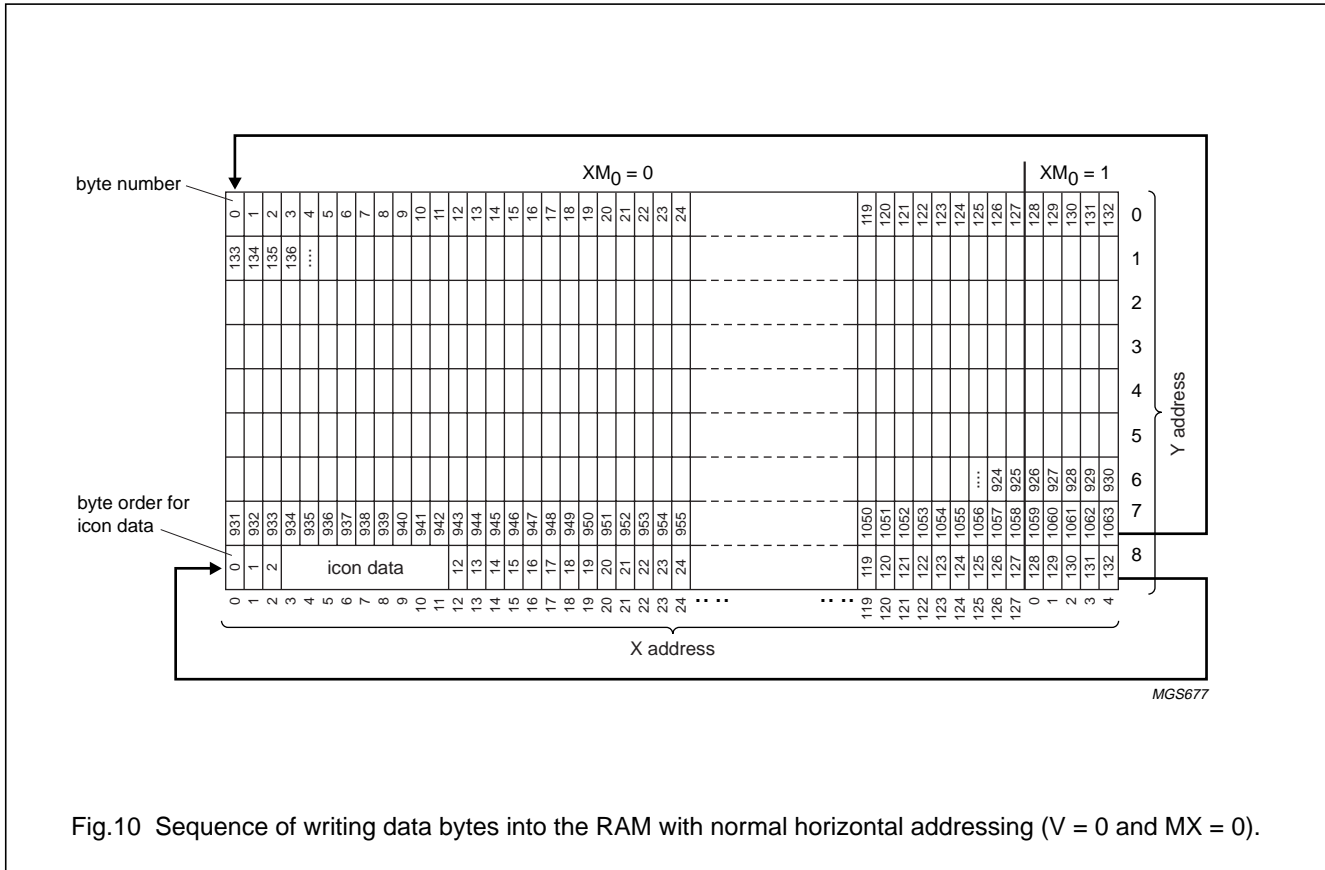

Fig.10 Sequence of writing data bytes into the RAM with normal horizontal addressing (V = 0 and MX = 0).

65 × 133 pixel matrix driver

PCF8535

7.15.1.4 Horizontal addressing: mirrored; V = 0 and MX = 1

It is also possible to write data from right to left, instead of from the normal left to right, still going top to bottom. In the mirrored horizontal addressing mode the X counter will auto-decrement from 4 to 0, clear the XM₀, then count 127 to 0 before wrapping around to 4 and setting the XM₀ bit (see Fig.10). On each wrap-over, the Y counter will increment. The last address accessible is Y = 7, X = 0 and XM₀ = 0; after this access the counter will wrap around to Y = 0, X = 4 and XM₀ = 1.

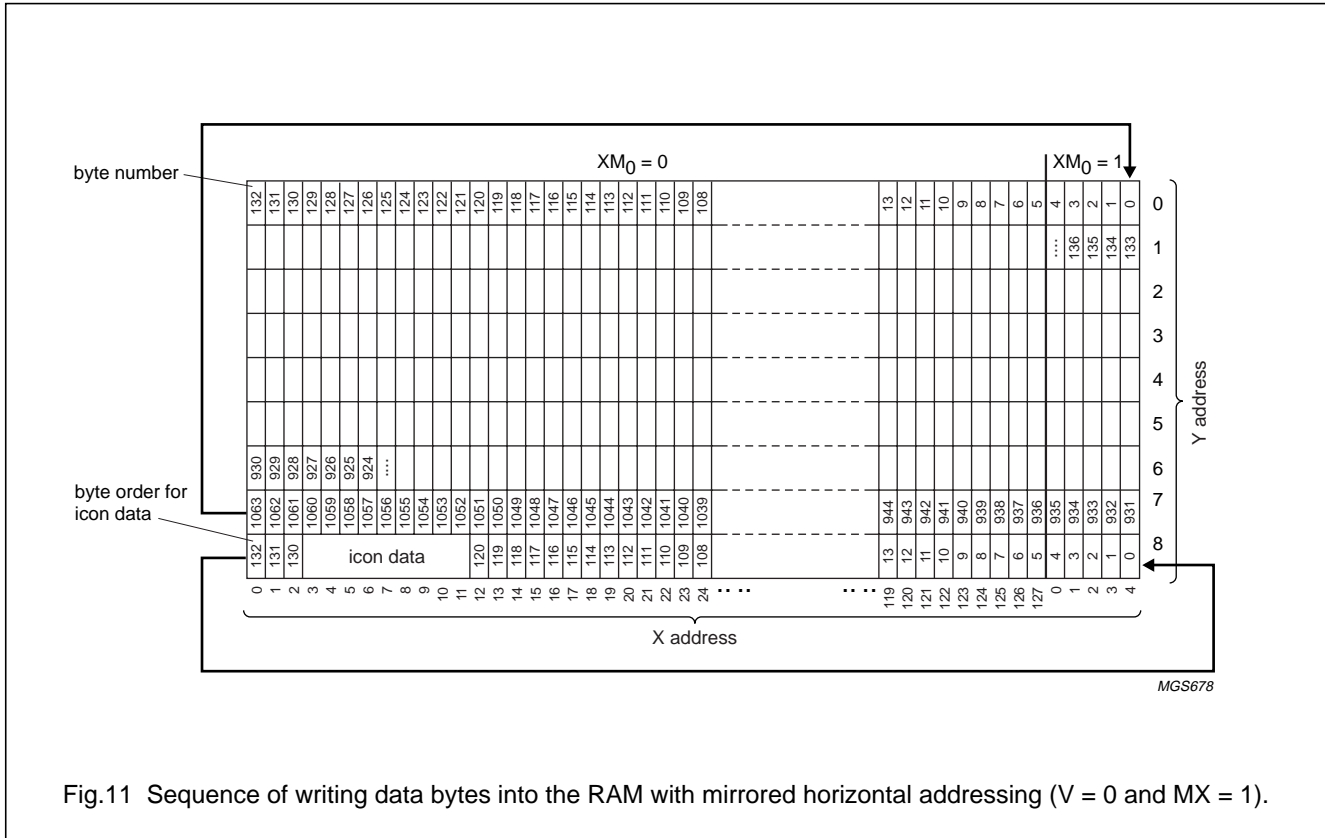

Fig.11 Sequence of writing data bytes into the RAM with mirrored horizontal addressing (V = 0 and MX = 1).

65 × 133 pixel matrix driver

PCF8535

7.15.2 OUTPUT ADDRESSING

The output addressing of the RAM is done automatically in accordance with the currently selected multiplex rate. Normally the user would not need to make any alterations to the addressing. There are, however, circumstances pertaining to various connectivity of the device on a glass that would benefit from some in-built functionality. Three modes exist that enable the user to modify the output addressing, namely:

1. MY, mirror the Y axis. This mode effectively flips the display about the X axis, resulting in an upside down display. The effect is observable immediately the bit is modified. This is useful if the device is to be mounted above the display area instead of below.
2. Bottom Row Swap (BRS). This mode swaps the order of the rows on the bottom⁽¹⁾ edge of the chip. This is useful to aide routing to the display when it is not possible to pass tracks under the device; a typical example would be in tape carrier package. This mode is often used in conjunction with TRS.
3. Top Row Swap (TRS). As with BRS, but swaps the order of rows on the top⁽¹⁾ edge of the chip.

7.15.2.1 Mirror Y, MY

As described above, the Y axis is mirrored in the X axis.

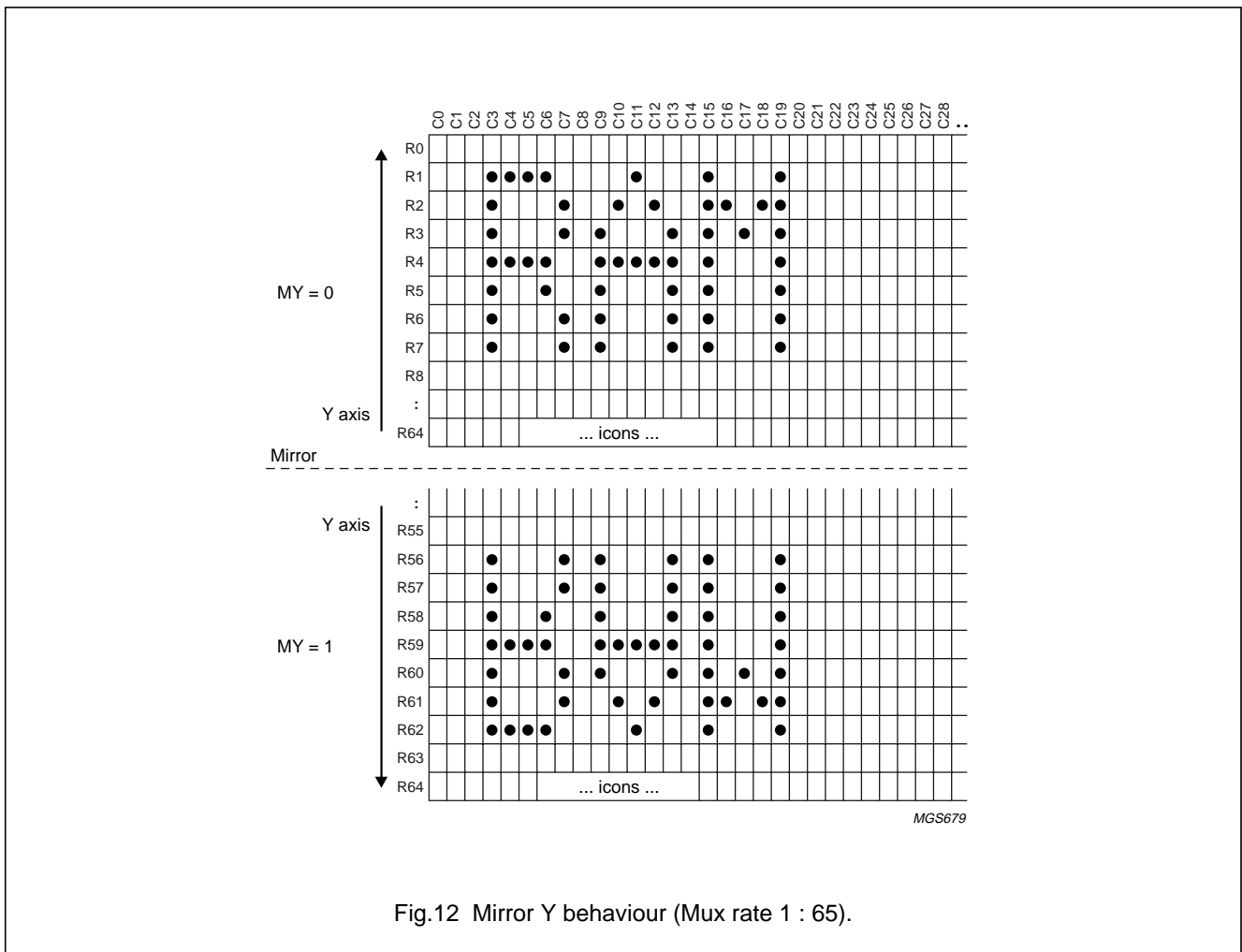

(1) The top edge is defined as the edge containing the user interface connections. The bottom edge is the opposing edge.

65 × 133 pixel matrix driver

PCF8535

7.15.2.2 Bottom Row Swap

Here the order of the row pads is modified. Each block of rows is swapped about its local Y axis.

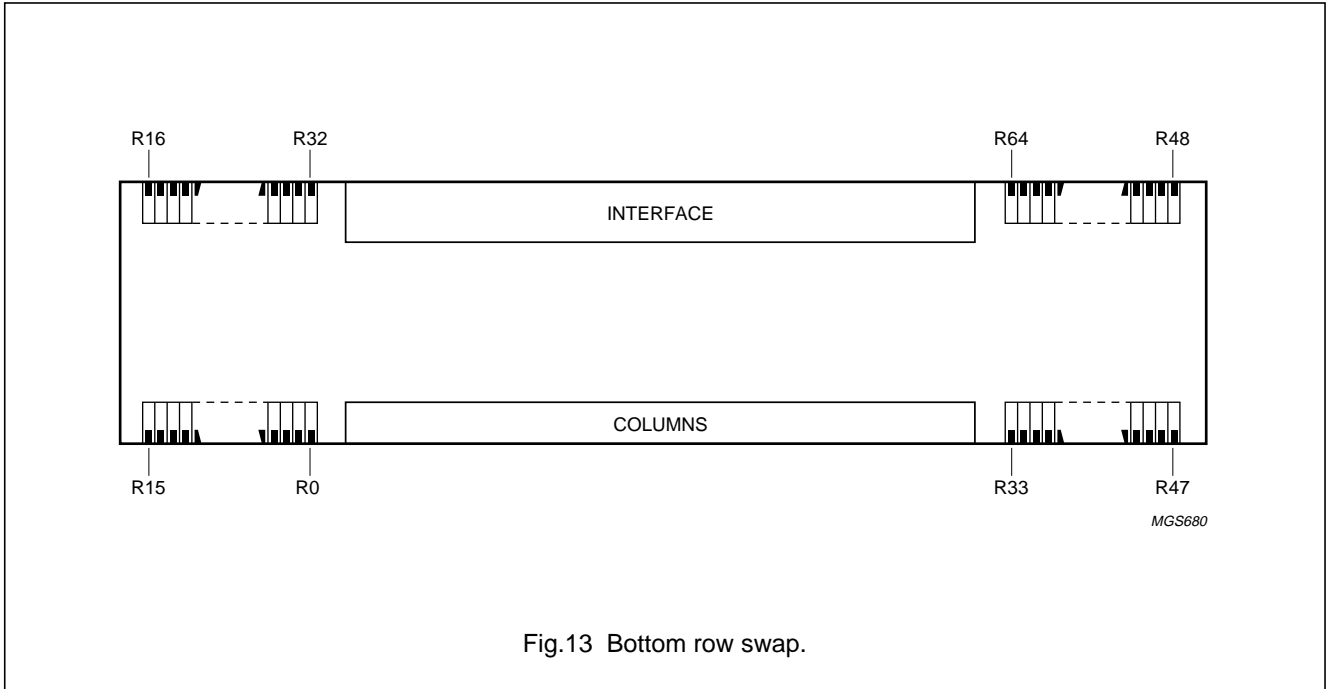

7.15.2.3 Top Row Swap

Here the order of the row pads is modified. Each block of rows is swapped about its local Y axis.

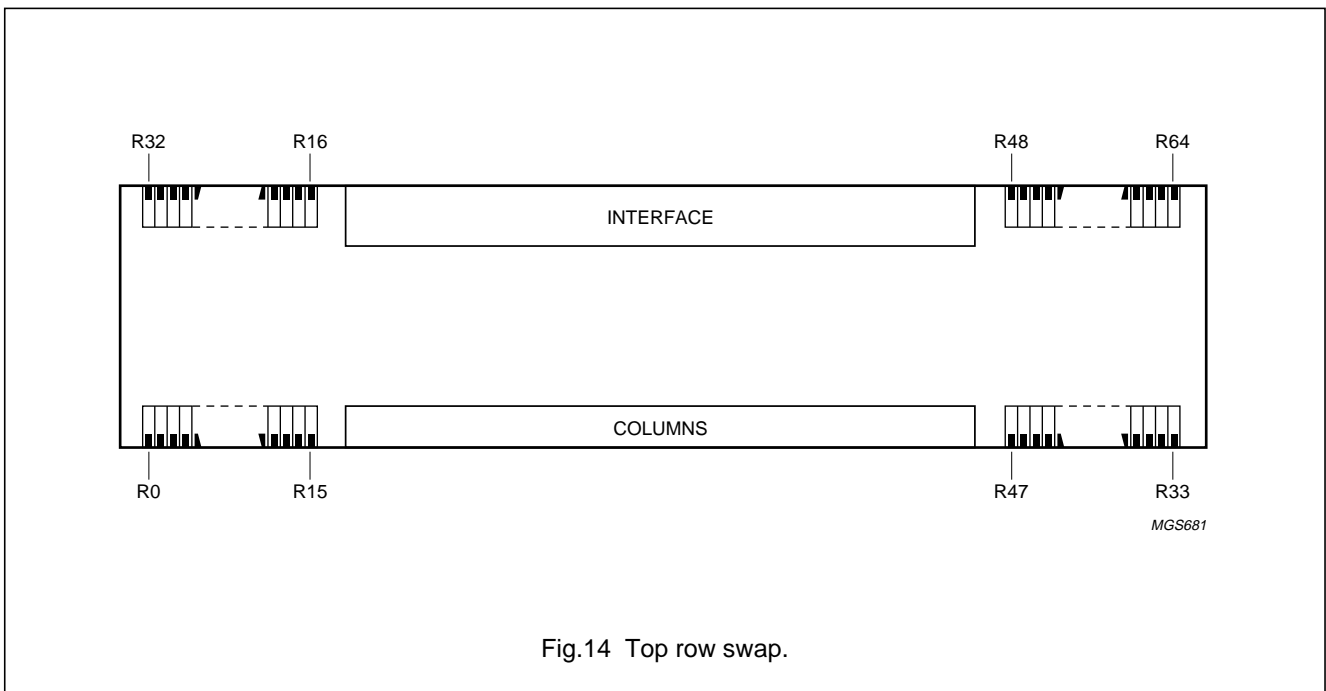

65 × 133 pixel matrix driver

PCF8535

7.15.2.4 Output row order

The order in which the rows are activated is a function of bits MY, TRS, BRS and the selected multiplex mode. Tables 9 to 12 give the order in which the rows are activated. In all cases, the RAM is accessed in a linear fashion, starting at zero with a jump to the last row for the icon data.

Table 9 Row order for BRS = 0 and TRS = 0

MULTIPLEX MODE	MY = 0	MY = 1
1 : 17	R0 to R15 and R64	R15 to R0 and R64
1 : 26	R0 to R24 and R64	R24 to R0 and R64
1 : 33	R0 to R31 and R64	R31 to R0 and R64
1 : 49	R0 to R47 and R64	R47 to R0 and R64
1 : 65	R0 to R64	R63 to R0 and R64

Table 10 Row order for BRS = 1 and TRS = 0

MULTIPLEX MODE	MY = 0	MY = 1
1 : 17	R15 to R0 and R64	R0 to R15 and R64
1 : 26	R15 to R0, R16 to R24 and R64	R24 to R16, R0 to R15 and R64
1 : 33	R15 to R0, R16 to R31 and R64	R31 to R16, R0 to R15 and R64
1 : 49	R15 to R0, R16 to R32, R47 to R33 and R64	R33 to R47, R32 to R16, R0 to R15 and R64
1 : 65	R15 to R0, R16 to R32, R47 to R33 and R48 to R64	R63 to R48, R33 to R47, R32 to R16, R0 to R15 and R64

Table 11 Row order for BRS = 0 and TRS = 1

MULTIPLEX MODE	MY = 0	MY = 1
1 : 17	R0 to R15 and R48	R15 to R0 and R48
1 : 26	R0 to R15, R32 to R24 and R48	R24 to R32, R15 to R0 and R48
1 : 33	R0 to R15, R32 to R17 and R48	R17 to R32, R15 to R0 and R48
1 : 49	R0 to R15, R32 to R16, R33 to R47 and R48	R47 to R33, R16 to R32, R15 to R0 and R48
1 : 65	R0 to R15, R32 to R16, R33 to R47 and R64 to R48	R49 to R64, R47 to R33, R16 to R32, R15 to R0 and R48

Table 12 Row order for BRS = 1 and TRS = 1

MULTIPLEX MODE	MY = 0	MY = 1
1 : 17	R15 to R0 and R48	R0 to R15 and R48
1 : 26	R15 to R0, R32 to R24 and R48	R0 to R15, R32 to R24 and R48
1 : 33	R15 to R0, R32 to R17 and R48	R0 to R15, R17 to R32 and R48
1 : 49	R15 to R0, R32 to R16, R47 to R33 and R48	R0 to R15, R16 to R32, R33 to R47 and R48
1 : 65	R15 to R0, R32 to R16, R47 to R33 and R64 to R48	R0 to R15, R16 to R32, R33 to R47, R47 to R64 and R48

65 × 133 pixel matrix driver

PCF8535

7.16 Instruction set

Data accesses to the PCF8535 can be broken down into two areas, those that define the operating mode of the device and those that fill the display RAM; the distinction being the D/C bit. When the D/C bit is at logic 0, the chip will respond to instructions as defined in Table 16. When the D/C bit is at logic 1, the chip will store data into the RAM. Data may be written to the chip that is independent to the presence of the display clock.

There are 4 instruction types. Those which:

1. Define PCF8535 functions such as display configuration, etc.
2. Set internal RAM addresses
3. Perform data transfer with internal RAM
4. Others.

In normal use, category 3 instructions are the most frequently used. To lessen the MPU program load, automatic incrementing by one of the internal RAM address pointers after each data write is implemented.

The instruction set is broken down into several pages, each command page being individually addressed via the H[2:0] bits.

7.16.1 RAM READ/WRITE COMMAND PAGE

This page is special in that it is accessible independently of the H bits. This page is mainly used as a stepping stone to other pages. Sending the 'Default H[2:0]' command will cause an immediate step to the 'Function and RAM command page' which will allow the H[2:0] bits to be set.

7.16.2 FUNCTION AND RAM COMMAND PAGE

7.16.2.1 Command page

Setting H[2:0] will move the user immediately to the required command page. Pages not listed should not be accessed as the behaviour is not defined.

7.16.2.2 Function set

PD

When PD = 1, the LCD driver is in power-down mode:

- All LCD outputs at V_{SS}

- Oscillator off
- V_{LCDIN} may be disconnected
- I²C-bus interface accesses are possible
- RAM contents are not cleared; RAM data can be written
- Register settings remain unchanged.

V

When V = 0, horizontal addressing is selected. When V = 1, vertical addressing is selected. The behaviour is described in Section 7.15.

7.16.2.3 RAM page

The XM₀ bit extends the RAM into a second page. The bit may be considered to be the Most Significant Bit (MSB) of an 8-bit X address. The behaviour is described in Section 7.15.

7.16.2.4 Set Yaddress

The Y address is used as a pointer to the RAM for RAM writing. The range is 0 to 8. Each bank corresponds to a set of 8 rows, the only exception being bank 8, which contains the icon data and is only 1-bit deep; see Table 13.

Table 13 Y address pointer

Y[3]	Y[2]	Y[1]	Y[0]	BANK	ROWS
0	0	0	0	bank 0	R0 to R7
0	0	0	1	bank 1	R8 to R15
0	0	1	0	bank 2	R16 to R23
0	0	1	1	bank 3	R24 to R31
0	1	0	0	bank 4	R32 to R39
0	1	0	1	bank 5	R40 to R47
0	1	1	0	bank 6	R48 to R55
0	1	1	1	bank 7	R56 to R63
1	0	0	0	bank 8 (icons)	R64

65 × 133 pixel matrix driver

PCF8535

7.16.2.5 Set X address

The X address is used as a pointer to the RAM for RAM writing. The range of X is 0 to 127 (7FH) and may be extended by the XM₀ bit. The combined value of XM₀ and X address directly corresponds to the display column number when MX = 0 and corresponds to the inverse display column number when MX = 1; see Table 14.

Table 14 X address pointer

XM ₀ , X[6:0]	ADDRESSED COLUMN, MX = 0	ADDRESSED COLUMN, MX = 1
0	C0	C132
1	C1	C131
2	C2	C130
3	C3	C129
:	:	:
129	C129	C3
130	C130	C2
131	C131	C1
132	C132	C0

7.16.3 DISPLAY SETTING COMMAND PAGE

7.16.3.1 Display control

The D and E bits set the display mode as given in Table 15.

Table 15 Display control

D	E	MODE
0	0	display blank
1	0	normal mode
0	1	all display segments on
1	1	inverse video

7.16.3.2 External display control

Mirror X and mirror Y have the effect of flipping the display left to right or top to bottom respectively. MX works by changing the order data that is written into the RAM. As such, the effects of toggling MX will only be seen after data is written into the RAM. MY works by reversing the order that column data is accessed relative to the row outputs. The effect of toggling MY will be seen immediately. The behaviour of both of these bits is further described in Section 7.15.

7.16.3.3 Bias system

BS[2:0] sets the bias system; see Section 7.10.

7.16.3.4 Display size

Physically large displays require stronger drivers. Bit IB enables the user to select a stronger driving mode and should be used if suitable display quality can not be achieved with the default setting.

7.16.3.5 Multiplex rate

M[2:0] sets the multiplex rate; see Section 7.9.

7.16.4 HV-GEN COMMAND PAGE

7.16.4.1 HV-gen control

PRS

Programmable charge pump range select. This bit defines whether the programmed voltage for V_{OP} is in the low or the high range. The behaviour of this bit is further described in Section 7.13.

HVE

High voltage generator enable. When set to logic 0, the charge pump is disabled. When set to logic 1, the charge pump is enabled.

7.16.4.2 HV-gen stages

S[1:0] set the multiplication factor of the charge pump ranging from times 2 to times 5. The behaviour of these bits is further described in Section 7.14.

7.16.4.3 Temperature coefficients

TC[2:0] set the required temperature coefficient. The behaviour of these bits is further described in Section 7.12.

7.16.4.4 Temperature measurement control

The SM bit is used to initiate a temperature measurement. The SM bit is automatically cleared at the end of the measurement. The behaviour of this bit is further described in Section 7.11.

7.16.4.5 V_{LCD} control

V_{OP}[6:0] sets the required operating voltage for the display.

65 × 133 pixel matrix driver

PCF8535

7.16.5 SPECIAL FEATURE COMMAND PAGE

7.16.5.1 State control

DM

Direct mode allows V_{LCDOUT} to be sourced directly from V_{DD2} . This may be useful in systems where V_{DD} is to be used for V_{LCD} .

DOF

Display off will turn off all internal analog circuitry that is not required for temperature measurement. As a consequence the display will be turned off. This mode is only required if temperature measurements are required whilst in power-down mode.

7.16.5.2 Oscillator setting

The internal oscillator may be disabled and the source clock for the display derived from the OSC pad. It is important to remember that LCDs are damaged by DC voltages and that the clock, whether derived internally or externally, should never be disabled whilst the display is active. The internal oscillator is switched off during power-down mode.

7.16.6 INSTRUCTION SET

Table 16 Instruction set

INSTRUCTION	D/C	R/W ⁽¹⁾	I ² C-BUS COMMAND BYTE								I ² C-BUS COMMANDS
			DB7	DB6	DB5	DB4	DB3	DB2	DB1	DB0	
H[2:0] = XXX; RAM read/write command page											
Write data	1	0	D ₇	D ₆	D ₅	D ₄	D ₃	D ₂	D ₁	D ₀	writes data to display RAM
Read status	0	1	D ₇	D ₆	D ₅	D ₄	D ₃	D ₂	D ₁	D ₀	returns result of temperature measurement
NOP	0	0	0	0	0	0	0	0	0	0	no operation
Default H[2:0]	0	0	0	0	0	0	0	0	0	1	jump to H[2:0] = 111
H[2:0] = 111; function and RAM command page											
Command page	0	0	0	0	0	0	1	H ₂	H ₁	H ₀	select command page
Function set	0	0	0	0	0	1	0	PD	V	0	power-down control, data entry mode
RAM page	0	0	0	0	1	0	0	X _{M0}	0	0	set RAM page for X address
Set Y address of RAM	0	0	0	1	0	0	0	Y ₃	Y ₂	Y ₁	sets Y address of RAM 0 ≤ Y ≤ 8
Set X address of RAM	0	0	1	X ₆	X ₅	X ₄	X ₃	X ₂	X ₁	X ₀	sets X address of RAM 0 ≤ X ≤ 127

When using an external clock and disabling it during power-down mode will further reduce the standby current. If it is not possible to disable it externally then it is worth noting that by selecting the internal clock, which is disabled during power-down mode, the same effect may be achieved.

7.16.5.3 COG/TCP

The chip may be mounted on either a glass, foil or tape carrier package. For these applications, different organizations of the row pads are required to negate the necessity of routing under the device. The TRS and BRS allow for this swapping. The behaviour of both of these bits is further described in Section 7.15.

65 × 133 pixel matrix driver

PCF8535

INSTRUCTION	D/ \bar{C}	R/ \bar{W} ⁽¹⁾	I ² C-BUS COMMAND BYTE								I ² C-BUS COMMANDS
			DB7	DB6	DB5	DB4	DB3	DB2	DB1	DB0	
H[2:0] = 110; display setting command page											
Display control	0	0	0	0	0	0	0	1	D	E	sets display mode
External display control	0	0	0	0	0	0	1	MX	MY	0	mirror X, mirror Y
Bias system	0	0	0	0	0	1	0	BS ₂	BS ₁	BS ₀	set bias system
Display size	0	0	0	0	1	0	0	IB	0	0	set current for bias system
Multiplex rate	0	0	1	0	0	0	0	M ₂	M ₁	M ₀	set multiplex rate
H[2:0] = 101; HV-gen command page											
HV-gen control	0	0	0	0	0	0	0	1	PRS	HVE	V _{LCD} range, enable/disable HV-gen
HV-gen stages	0	0	0	0	0	0	1	0	S ₁	S ₀	# of HV-gen voltage multiplication
Temperature coefficients	0	0	0	0	0	1	0	TC ₂	TC ₁	TC ₀	set temperature coefficient
Temperature measurement control	0	0	0	0	1	0	0	0	0	SM	start temperature measurement
V _{LCD} control	0	0	1	V _{OP6}	V _{OP5}	V _{OP4}	V _{OP3}	V _{OP2}	V _{OP1}	V _{OP0}	set V _{LCD} register 0 ≤ V _{LCD} ≤ 127
H[2:0] = 011; special feature command page											
State control	0	0	0	0	0	0	0	1	DOF	DM	display off, direct mode
Oscillator setting	0	0	0	0	0	0	1	0	EC	0	enable/disable the internal oscillator
COG/TCP	0	0	0	1	0	TRS	BRS	0	0	0	top row swap, bottom row swap

Note

1. R/ \bar{W} is set in the slave address.

65 × 133 pixel matrix driver

PCF8535

Table 17 Description of the symbols used in Table 16

BIT	0	1
PD	chip is active	chip is in power-down mode
V	horizontal addressing	vertical addressing
HVE	voltage multiplier disabled	voltage multiplier enabled
PRS	V _{LCD} programming range LOW	V _{LCD} programming range HIGH
SM	no measurement	start measurement
MX	no X mirror	mirror X
MY	no Y mirror	mirror Y
TRS	top row swap inactive	top row swap active
BRS	bottom row swap inactive	bottom row swap active
EC	internal oscillator enabled; OSC pad ignored	internal oscillator disabled; OSC pad enabled for input
DM ⁽¹⁾	direct mode disabled	direct mode enabled
DOF ⁽¹⁾	display off mode disabled	display off mode enabled
IB	low current mode for smaller displays	high current mode for larger displays

Note

1. Conditional on other bits.

Table 18 Priority behaviour of bits PD, DOF, HVE and DM; note 1

PD	DOF	HVE	DM	MODE
1	X	X	X	chip is in power-down mode as defined under PD
0	1	X	X	all analog blocks except those required for temperature measurement are off
0	0	1	X	chip is active and using the internal V _{LCD} generator
0	0	0	1	chip is active and using V _{DD} as V _{LCD}
0	0	0	0	chip is active and using an external V _{LCD} generator attached to V _{LCDIN}

Note

1. X = don't care state.

65 × 133 pixel matrix driver

PCF8535

7.17 I²C-bus interface

7.17.1 CHARACTERISTICS OF THE I²C-BUS

The I²C-bus is for bidirectional, two-line communication between different ICs or modules. The two lines are a serial data line (SDA) and a serial clock line (SCL). Both lines must be connected to a positive supply via a pull-up resistor. Data transfer may be initiated only when the bus is not busy.

7.17.1.1 Bit transfer

One data bit is transferred during each clock pulse. The data on the SDA line must remain stable during the HIGH period of the clock pulse as changes in the data line at this time will be interpreted as a control signal. Bit transfer is illustrated in Fig.15.

7.17.1.2 START and STOP conditions

Both data and clock lines remain HIGH when the bus is not busy. A HIGH-to-LOW transition of the data line, while the clock is HIGH is defined as the START condition (S). A LOW-to-HIGH transition of the data line while the clock is HIGH is defined as the STOP condition (P). The START and STOP conditions are illustrated in Fig.16.

7.17.1.3 System configuration

The system configuration is illustrated in Fig.17.

- Transmitter: the device which sends the data to the bus
- Receiver: the device which receives the data from the bus
- Master: the device which initiates a transfer, generates clock signals and terminates a transfer

- Slave: the device addressed by a master
- Multi-master: more than one master can attempt to control the bus at the same time without corrupting the message
- Arbitration: procedure to ensure that, if more than one master simultaneously tries to control the bus, only one is allowed to do so and the message is not corrupted
- Synchronization: procedure to synchronize the clock signals of two or more devices.

7.17.1.4 Acknowledge

Each byte of 8 bits is followed by an acknowledge bit. The acknowledge bit is a HIGH signal put on the bus by the transmitter during which time the master generates an extra acknowledge related clock pulse. A slave receiver which is addressed must generate an acknowledge after the reception of each byte. Also a master receiver must generate an acknowledge after the reception of each byte that has been clocked out of the slave transmitter.

The device that acknowledges must pull-down the SDA line during the acknowledge clock pulse, so that the SDA line is stable LOW during the HIGH period of the acknowledge related clock pulse (set-up and hold times must be taken into consideration). A master receiver must signal an end of data to the transmitter by not generating an acknowledge on the last byte that has been clocked out of the slave. In this event the transmitter must leave the data line HIGH to enable the master to generate a STOP condition. Acknowledgement on the I²C-bus is illustrated in Fig.18.

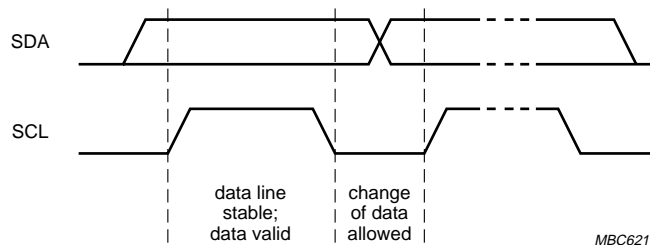
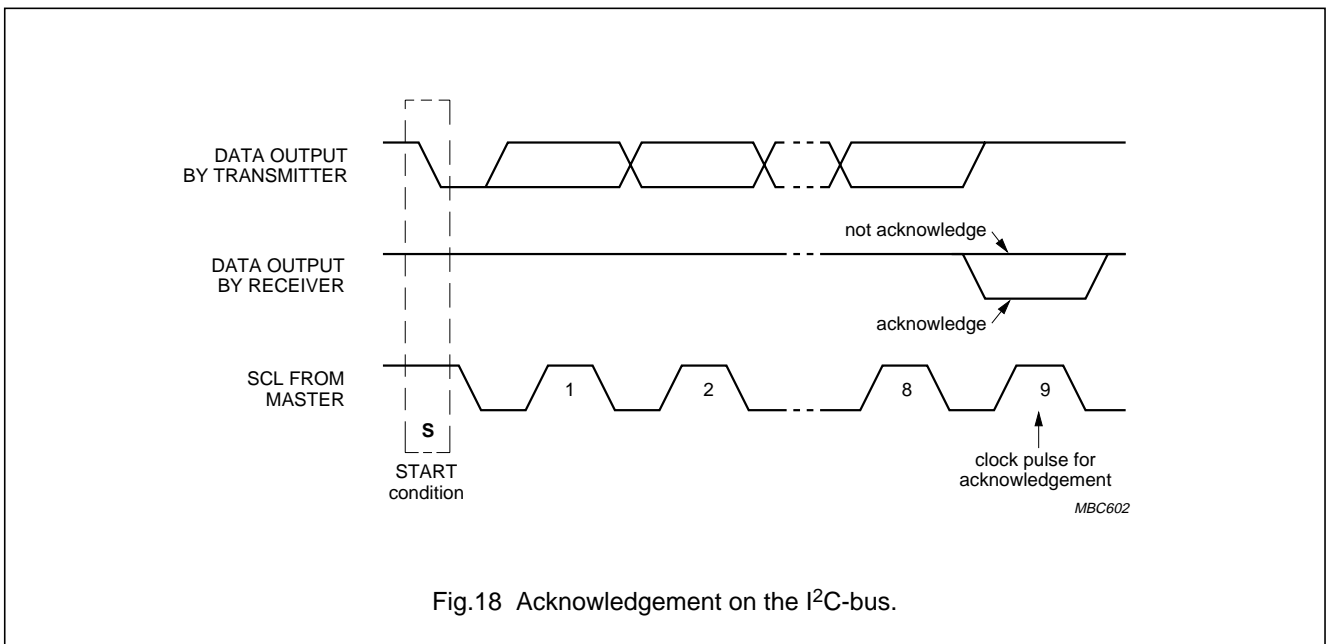
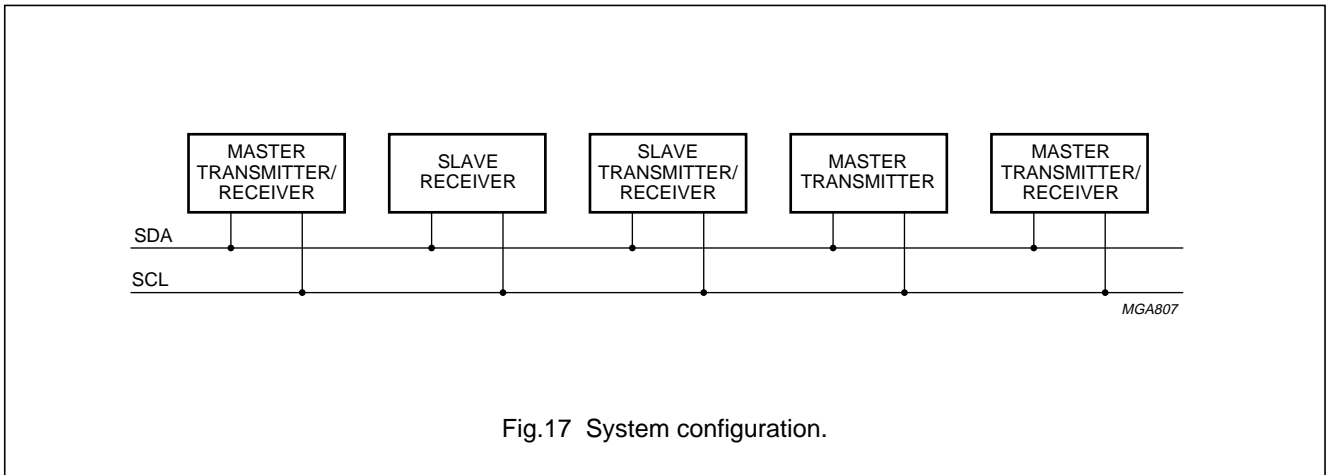
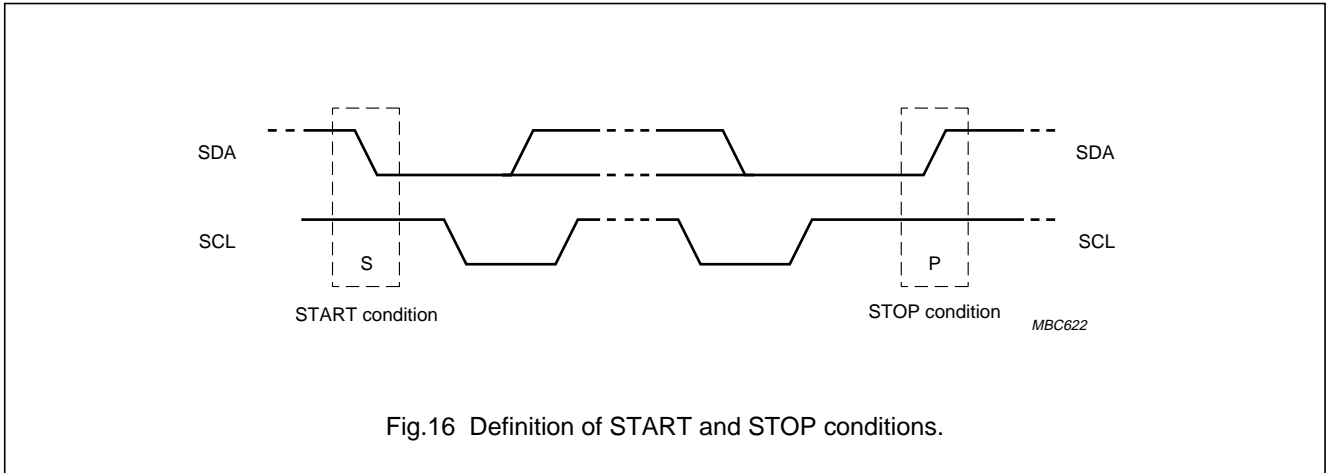

Fig.15 Bit transfer.

65 × 133 pixel matrix driver

PCF8535



65 × 133 pixel matrix driver

PCF8535

7.17.2 I²C-BUS PROTOCOL

The PCF8535 is a slave receiver/transmitter. If data is to be read from the device the SDAOUT pad must be connected, otherwise SDAOUT is unused.

Before any data is transmitted on the I²C-bus, the device which should respond is addressed. Four slave addresses, 0111100, 0111101, 0111110 and 0111111 are reserved for the PCF8535. The Least Significant Bits (LSBs) of the slave address is set by connecting SA1 and SA0 to either logic 0 (V_{SS}) or logic 1 (V_{DD}).

A sequence is initiated with a START condition (S) from the I²C-bus master which is followed by the slave address. All slaves with the corresponding address acknowledge in parallel, all the others will ignore the I²C-bus transfer.

After the acknowledgement cycle of a write, a control byte follows which defines the destination for the forthcoming data byte and the mode for subsequent bytes. For a read, the PCF8535 will immediately start to output the requested data until a NOT acknowledge is transmitted by the master. The sequence should be terminated by a STOP in the event that no further access is required for the time being, or by a RE-START, should further access be required.

For ease of operation a continuation bit, Co, has been included. This bit allows the user to set-up the chip configuration and transmit RAM data in one access. A data selection bit, D/C, defines the destination for data. These bits are contained in the control byte. DB5 to DB0 should be set to logic 0. These bits are reserved for future expansion.

Table 19 Co and D/C definitions

BIT	0/1	R/W	ACTION
Co	0	n.a.	last control byte to be sent: only a stream of data bytes are allowed to follow; this stream may only be terminated by a STOP or RE-START condition
	1		another control byte will follow the data byte unless a STOP or RE-START condition is received
D/C	0	0	data byte will be decoded and used to set up the device
		1	data byte will return the contents of the currently selected status register
	1	0	data byte will be stored in the display RAM
		1	no provision for RAM read back is provided

An example of a write access is given in Fig.19. Here, multiple instruction data is sent, followed by multiple display bytes. An example of a read access is given in Fig.20.

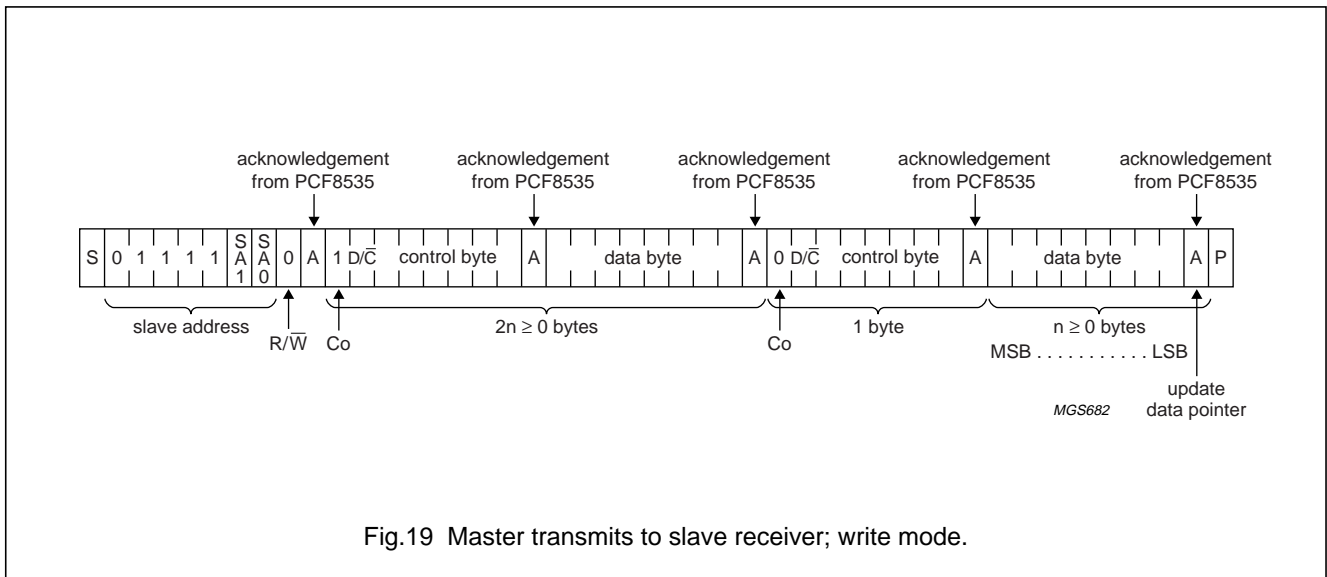
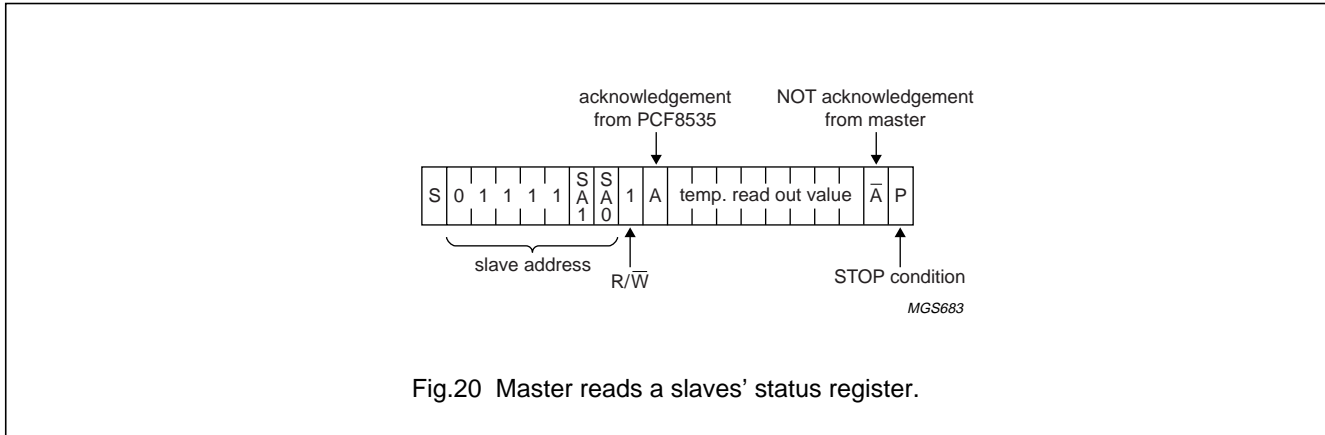

Fig.19 Master transmits to slave receiver; write mode.

65 × 133 pixel matrix driver

PCF8535



8 LIMITING VALUES (PROVISIONAL)

In accordance with the Absolute Maximum Rating System (IEC 134); notes 1, 2 and 3.

SYMBOL	PARAMETER	MIN.	MAX.	UNIT
V _{DD}	supply voltage	-0.5	+7.0	V
I _{DD}	supply current	-50	+50	mA
V _{LCD}	LCD supply voltage	-0.5	+17.0	V
I _{LCD}	LCD supply current	-50	+50	mA
I _{SS}	negative supply current	-50	+50	mA
V _I /V _O	input/output voltage (any input/output)	-0.5	V _{DD} + 0.5	V
I _I	DC input current	-10	+10	mA
I _O	DC output current	-10	+10	mA
P _{tot}	total power dissipation per package	-	300	mW
P/out	power dissipation per output	-	30	mW
T _{amb}	ambient temperature	-40	+85	°C
T _{stg}	storage temperature	-65	+150	°C
T _{j(max)}	maximum junction temperature	-	150	°C

Notes

1. Stresses above these values listed may cause permanent damage to the device.
2. Parameters are valid over the operating temperature range unless otherwise specified. All voltages are referenced to V_{SS} unless otherwise specified.
3. V_{SS} = 0 V.

9 HANDLING

Inputs and outputs are protected against electrostatic discharge in normal handling. However, to be totally safe, it is recommended to take normal precautions appropriate to handling MOS devices (see "Handling MOS Devices").

65 × 133 pixel matrix driver

PCF8535

10 DC CHARACTERISTICS

$V_{DD} = 4.5$ to 5.5 V; $V_{SS} = 0$ V; $V_{LCD} = 4.5$ to 16.0 V; $T_{amb} = -40$ to $+85$ °C; unless otherwise specified.

SYMBOL	PARAMETER	CONDITIONS	MIN.	TYP.	MAX.	UNIT
Supplies						
V_{LCDIN}	LCD supply voltage	Mux mode 1 : 65	8.0	–	16.0	V
		Mux mode 1 : 49	8.0	–	16.0	V
		Mux mode 1 : 34	–	–	16.0	V
		Mux mode 1 : 26	–	–	16.0	V
		Mux mode 1 : 17	–	–	16.0	V
I_{LCDIN}	LCD supply current	normal mode; notes 1 and 2	–	40	90	µA
		normal mode; notes 1 and 4	–	18	40	µA
V_{LCDOUT}	generated supply voltage	LCD voltage generator enabled	–	–	16.0	V
V_{DD1} , V_{DD2} , V_{DD3}	supply voltage		4.5	–	5.5	V
I_{DD}	supply current	power-down mode; notes 1, 3 and 5	–	2	10	µA
		display off mode; notes 1 and 5	–	–	–	µA
		normal mode; notes 1 and 6	–	160	350	µA
		normal mode; notes 1 and 2	–	40	90	µA
Logic						
V_{IL}	LOW-level input voltage		V_{SS}	–	$0.3V_{DD}$	V
V_{IH}	HIGH-level input voltage		$0.7V_{DD}$	–	V_{DD}	V
I_{OL}	LOW-level output current (SDA)	$V_{OL} = 0.4$ V; $V_{DD} = 5$ V	3.0	–	–	mA
I_L	leakage current	$V_I = V_{DD}$ or V_{SS}	–1	–	+1	µA
Column and row outputs						
$R_{O(col)}$	column output resistance C0 to C132	$V_{LCD} = 12$ V; note 7	–	–	10	kΩ
$R_{O(row)}$	row output resistance R0 to R33	$V_{LCD} = 12$ V; note 7	–	–	3.0	kΩ
$V_{bias(col)}$	bias tolerance C0 to C132		–100	0	+100	mV
$V_{bias(row)}$	bias tolerance R0 to R64		–100	0	+100	mV
Temperature coefficient						
t_{cut}	cut point temperature	$T_{amb} = -20$ to $+70$ °C	–	27	–	°C

Notes

- LCD outputs are open-circuit, inputs at V_{DD} or V_{SS} , bus inactive, f_{OSC} = typical internal oscillator frequency.
- Conditions are: V_{DD1} to $V_{DD3} = 5.0$ V, $V_{LCD} = 12.0$ V and external V_{LCD} .
- Power-down mode. During power-down all static currents are switched off.
- Conditions are: V_{DD1} to $V_{DD3} = 5.0$ V, $V_{LCD} = V_{DD2}$ and external V_{LCD} .
- Internal V_{LCD} generation or external V_{LCD} .
- Conditions are: V_{DD1} to $V_{DD3} = 5.0$ V, $V_{LCD} = 12.0$ V and voltage multiplier = $3V_{DD}$.
- $I_{LCD} = 10$ µA. Outputs tested one at a time.

65 × 133 pixel matrix driver

PCF8535

11 AC CHARACTERISTICS

$V_{DD} = 4.5$ to 5.5 V; $V_{SS} = 0$ V; $V_{LCD} = 4.5$ to 16.0 V; $T_{amb} = -40$ to $+85$ °C; unless otherwise specified.

SYMBOL	PARAMETER	CONDITIONS	MIN.	TYP.	MAX.	UNIT
$f_{fr(LCD)}$	LCD frame frequency (internal clock)		48	80	165	Hz
$f_{clk(ext)}$	external clock frequency	see Table 20	120	–	410	kHz
$t_{W(RESL)}$	reset LOW pulse width		1	–	–	μs
$t_{W(RESH)}$	reset HIGH pulse width		5	–	–	μs
$t_{SU;RESL}$	reset LOW pulse set-up time after power-on	notes 1 and 2	–	–	30	μs
$t_{R(op)}$	end of reset pulse to interface being operational		–	–	3	μs
Serial-bus interface; note 3						
f_{SCL}	SCL clock frequency		0	–	400	kHz
t_{LOW}	SCL clock LOW period		1.3	–	–	μs
t_{HIGH}	SCL clock HIGH period		0.6	–	–	μs
$t_{SU;DAT}$	data set-up time		100	–	–	ns
$t_{HD;DAT}$	data hold time		0	–	0.9	μs
t_r	SCL, SDA rise time	note 4	$20 + 0.1C_b$	–	300	ns
t_f	SCL, SDA fall time	note 4	$20 + 0.1C_b$	–	300	ns
C_b	capacitive load represented by each bus line		–	–	400	pF
$t_{SU;STA}$	set-up time for a repeated START condition		0.6	–	–	μs
$t_{HD;STA}$	START condition hold time		0.6	–	–	μs
$t_{SU;STO}$	set-up time for STOP condition		0.6	–	–	μs
t_{SP}	tolerable spike width on bus		–	–	50	ns
t_{BUF}	bus free time between a STOP and START condition		1.3	–	–	μs

Notes

- V_{DD1} to $V_{DD3} = 5$ V.
- Decoupling capacitor V_{LCD} and $V_{SS} = 100$ nF (higher capacitor size increases $t_{SU;RESL}$ and higher V_{DD1} to V_{DD3} reduces $t_{SU;RESL}$).
- All timing values are valid within the operating supply voltage and ambient temperature range and are referenced to V_{IL} and V_{IH} with an input voltage swing of V_{SS} to V_{DD} .
- $C_b =$ total capacitance of one bus line in pF.

65 × 133 pixel matrix driver

PCF8535

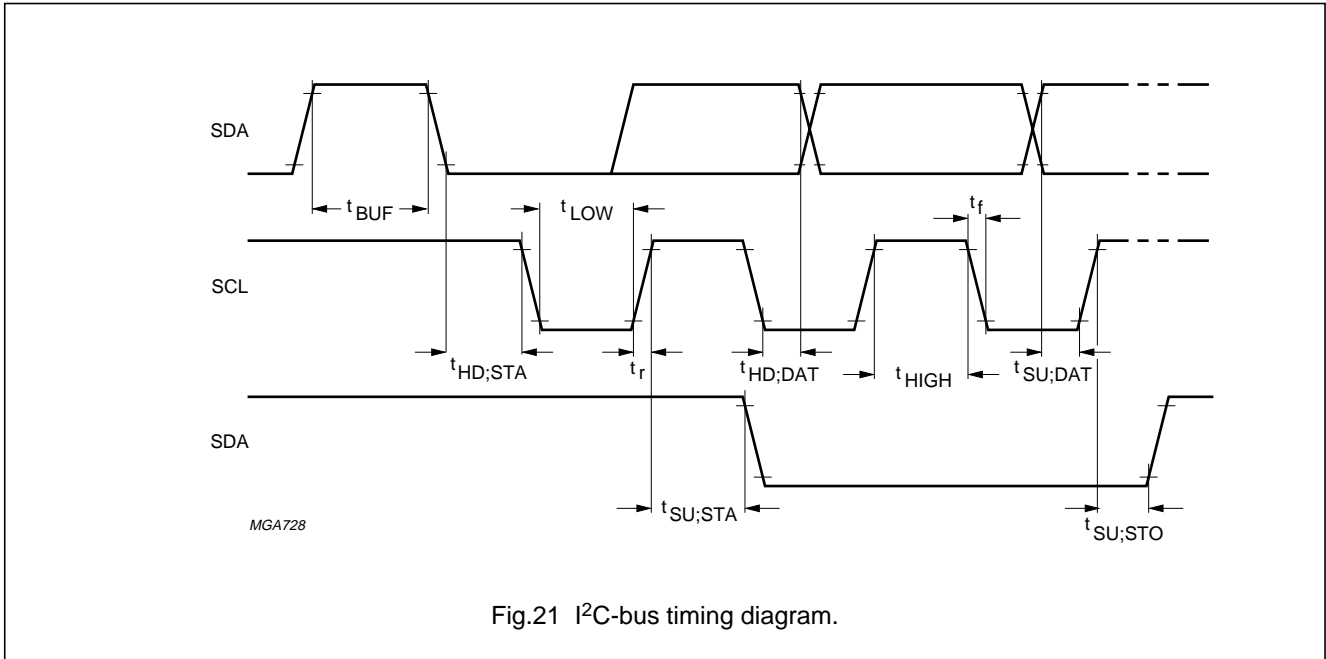

Fig.21 I²C-bus timing diagram.

Table 20 External clock frequency

MUX MODE	DIVISION RATIO	EXTERNAL CLOCK FREQUENCY FOR AN 80 Hz FRAME FREQUENCY (DIVISION RATIO × 80 Hz)
1 : 65	3168	253 kHz
1 : 48	3136	251 kHz
1 : 33	2720	218 kHz
1 : 26	2592	207 kHz
1 : 17	2592	207 kHz

65 × 133 pixel matrix driver

PCF8535

12 RESET TIMING

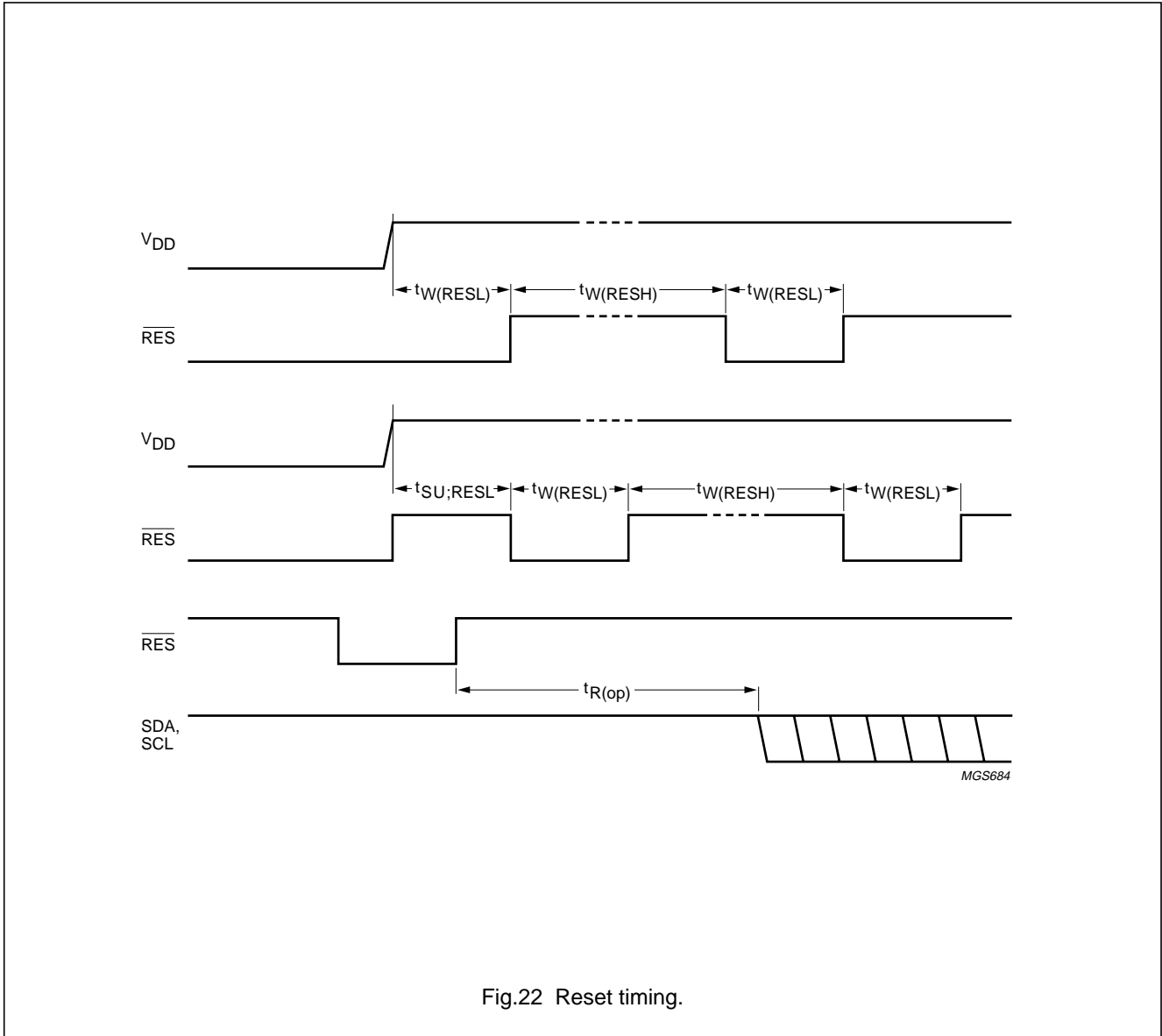

65 × 133 pixel matrix driver

PCF8535

13 APPLICATION INFORMATION

Table 21 Programming example for PCF8535

STEP	SERIAL BUS BYTE	DISPLAY ⁽¹⁾	OPERATION
1	START condition	BLANK	start
2	DB7 DB6 DB5 DB4 DB3 DB2 DB1 DB0 0 1 1 1 1 SA1 SA0 0	BLANK	slave address, $R/\overline{W} = 0$
3	DB7 DB6 DB5 DB4 DB3 DB2 DB1 DB0 0 0 0 0 0 0 0 0	BLANK	control byte, $Co = 0, D/\overline{C} = 0$
4	DB7 DB6 DB5 DB4 DB3 DB2 DB1 DB0 0 0 0 0 0 0 0 1	BLANK	H[2:0] independent command; select function and RAM command page H[1:0] = 111
5	DB7 DB6 DB5 DB4 DB3 DB2 DB1 DB0 0 0 0 1 0 0 0 0	BLANK	function and RAM command page; PD = 0, V = 0
6	DB7 DB6 DB5 DB4 DB3 DB2 DB1 DB0 0 0 0 0 1 1 1 0	BLANK	function and RAM command page; select display setting command page H[1:0] = 110
7	DB7 DB6 DB5 DB4 DB3 DB2 DB1 DB0 0 0 0 1 0 0 1 0	BLANK	display setting command page; set bias system to $1/9BS[2:0] = 010$
8	DB7 DB6 DB5 DB4 DB3 DB2 DB1 DB0 0 0 0 0 0 1 1 0	BLANK	display setting command page; set normal mode (D = 1, E = 0)
9	DB7 DB6 DB5 DB4 DB3 DB2 DB1 DB0 1 0 0 0 0 1 0 0	BLANK	select Mux rate 1 : 65
10	DB7 DB6 DB5 DB4 DB3 DB2 DB1 DB0 0 0 0 0 0 0 0 1	BLANK	H[2:0] independent command; select function and RAM command page H[1:0] = 111
11	DB7 DB6 DB5 DB4 DB3 DB2 DB1 DB0 0 0 0 0 1 1 0 1	BLANK	function and RAM command page; select Hv-gen command page H[1:0] = 101
12	DB7 DB6 DB5 DB4 DB3 DB2 DB1 DB0 0 0 0 0 1 0 0 1	BLANK	Hv-gen command page; select voltage multiplication factor 3 S[1:0] = 01
13	DB7 DB6 DB5 DB4 DB3 DB2 DB1 DB0 0 0 0 1 0 0 1 0	BLANK	Hv-gen command page; select temperature coefficient 2 TC[2:0] = 010
14	DB7 DB6 DB5 DB4 DB3 DB2 DB1 DB0 1 0 1 0 1 0 0 0	BLANK	Hv-gen command page; set $V_{LCD} = 12.02 V$; $V_{OP}[6:0] = 0101000$
15	DB7 DB6 DB5 DB4 DB3 DB2 DB1 DB0 0 0 0 0 0 1 1 1	BLANK	Hv-gen command page; select high V_{LCD} programming range (PRS = 1), voltage multiplier on (HVE = 1)
16	START condition	BLANK	repeat start
17	DB7 DB6 DB5 DB4 DB3 DB2 DB1 DB0 0 1 1 1 1 SA1 SA0 0	BLANK	slave address, $R/\overline{W} = 0$
18	DB7 DB6 DB5 DB4 DB3 DB2 DB1 DB0 0 1 0 0 0 0 0 0	BLANK	control byte, $Co = 0, D/\overline{C} = 1$

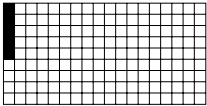
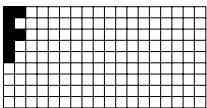
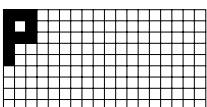
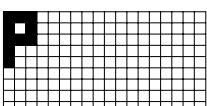
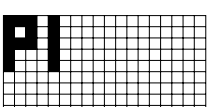
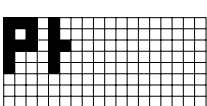
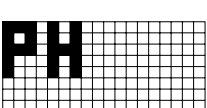
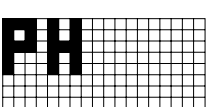

65 × 133 pixel matrix driver

PCF8535

STEP	SERIAL BUS BYTE	DISPLAY ⁽¹⁾	OPERATION
19	DB7 DB6 DB5 DB4 DB3 DB2 DB1 DB0 0 0 0 1 1 1 1 1	 <small>MGS405</small>	data write; Y, X are initialized to logic 0 by default, so they are not set here
20	DB7 DB6 DB5 DB4 DB3 DB2 DB1 DB0 0 0 0 0 0 1 0 1	 <small>MGS406</small>	data write
21	DB7 DB6 DB5 DB4 DB3 DB2 DB1 DB0 0 0 0 0 0 1 1 1	 <small>MGS407</small>	data write
22	DB7 DB6 DB5 DB4 DB3 DB2 DB1 DB0 0 0 0 0 0 0 0 0	 <small>MGS408</small>	data write
23	DB7 DB6 DB5 DB4 DB3 DB2 DB1 DB0 0 0 0 1 1 1 1 1	 <small>MGS409</small>	data write
24	DB7 DB6 DB5 DB4 DB3 DB2 DB1 DB0 0 0 0 0 0 1 0 0	 <small>MGS410</small>	data write
25	DB7 DB6 DB5 DB4 DB3 DB2 DB1 DB0 0 0 0 1 1 1 1 1	 <small>MGS411</small>	data write, last data, stop transmission
26	START condition		repeat start
27	DB7 DB6 DB5 DB4 DB3 DB2 DB1 DB0 0 1 1 1 1 SA1 SA0 0	 <small>MGS411</small>	slave address, R/W = 0



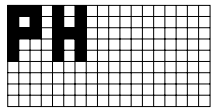
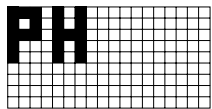
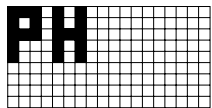
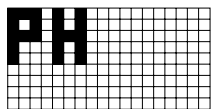
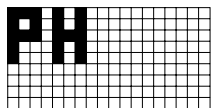

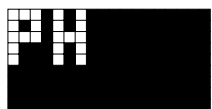
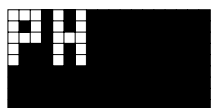
65 × 133 pixel matrix driver

PCF8535

STEP	SERIAL BUS BYTE	DISPLAY ⁽¹⁾	OPERATION
28	DB7 DB6 DB5 DB4 DB3 DB2 DB1 DB0 1 0 0 0 0 0 0 0		control byte, Co = 1, D/C = 0
29	DB7 DB6 DB5 DB4 DB3 DB2 DB1 DB0 0 0 0 0 0 0 0 1		H[1:0] independent command; select function and RAM command page H[1:0] = 111
30	DB7 DB6 DB5 DB4 DB3 DB2 DB1 DB0 1 0 0 0 0 0 0 0		control byte, Co = 1, D/C = 0
31	DB7 DB6 DB5 DB4 DB3 DB2 DB1 DB0 0 0 0 0 1 1 1 0		function and RAM command page; select display setting command page H[1:0] = 110
32	DB7 DB6 DB5 DB4 DB3 DB2 DB1 DB0 1 0 0 0 0 0 0 0		control byte, Co = 1, D/C = 0
33	DB7 DB6 DB5 DB4 DB3 DB2 DB1 DB0 0 0 0 0 1 1 0 1		display control; set inverse video mode (D = 1, E = 1)
34	DB7 DB6 DB5 DB4 DB3 DB2 DB1 DB0 1 0 0 0 0 0 0 0		control byte, Co = 1, D/C = 0
35	DB7 DB6 DB5 DB4 DB3 DB2 DB1 DB0 1 0 0 0 0 0 0 0		set X address of RAM; set address to '0000000'

65 × 133 pixel matrix driver

PCF8535

STEP	SERIAL BUS BYTE	DISPLAY ⁽¹⁾	OPERATION
36	DB7 DB6 DB5 DB4 DB3 DB2 DB1 DB0 0 1 0 0 0 0 0 0	 <p>MGS412</p>	control byte, Co = 0, D/C = 1
37	DB7 DB6 DB5 DB4 DB3 DB2 DB1 DB0 0 0 0 0 0 0 0 0	 <p>MGS414</p>	data write
38	DB7 DB6 DB5 DB4 DB3 DB2 DB1 DB0 0 0 0 0 0 0 0 0	 <p>MGS685</p>	data write
39	DB7 DB6 DB5 DB4 DB3 DB2 DB1 DB0 0 0 0 0 0 0 0 0	 <p>MGS686</p>	data write
40	STOP condition		end of transfer

Note

1. Assumes the display RAM was previously empty.

The pinning of the PCF8535 is optimized for single plane wiring e.g. for chip-on-glass display modules.

Display size: 65 × 133 pixels.

65 × 133 pixel matrix driver

PCF8535

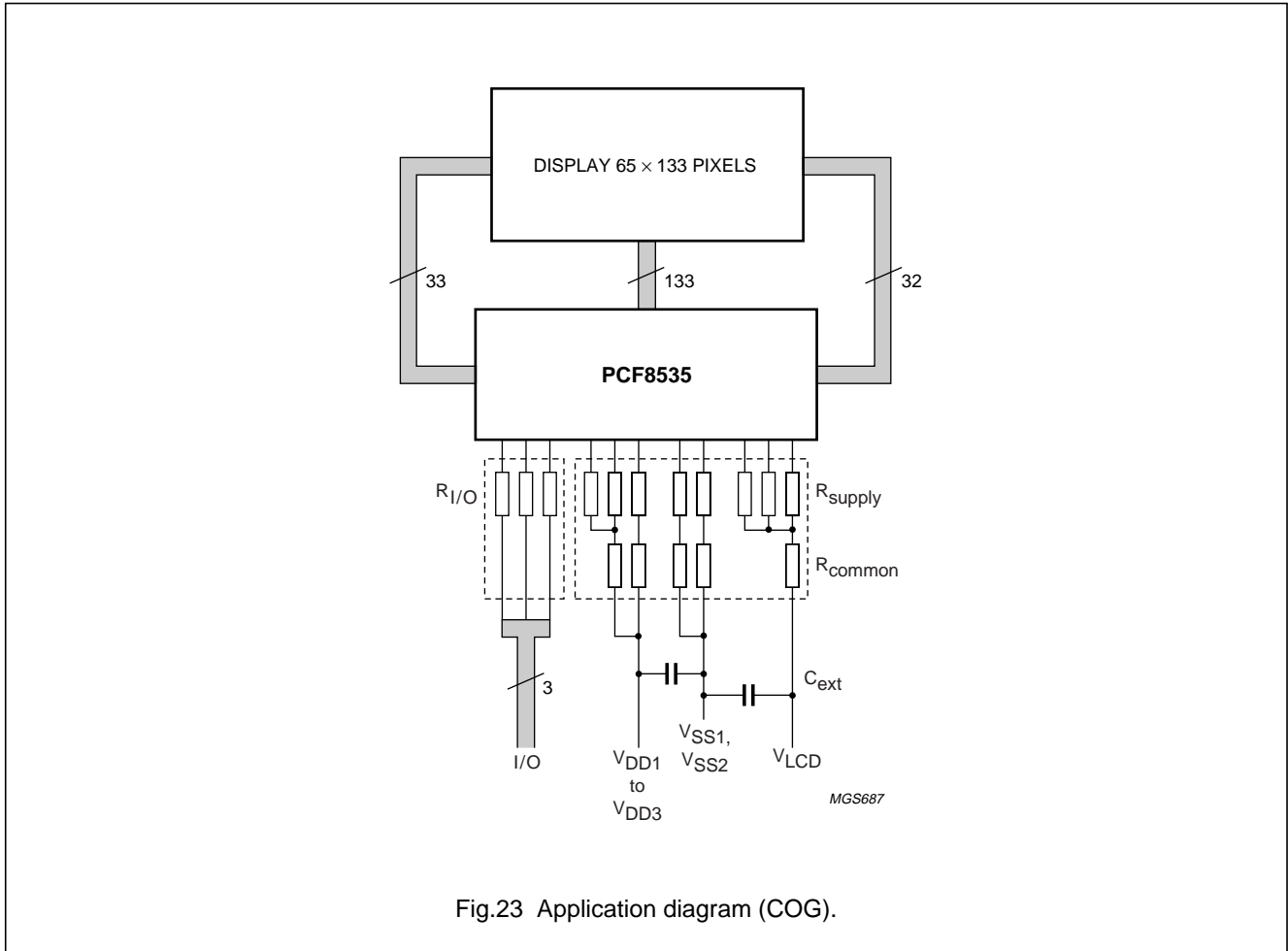

Fig.23 Application diagram (COG).

The required minimum value for the external capacitors in an application with the PCF8535 are:

C_{ext} for V_{LCD}, V_{SS1} and V_{SS2} = 100 nF (min.) (recommended 470 nF to 1 μF); C_{ext} for V_{DD1} to V_{DD3}, V_{SS1} and V_{SS2} = 470 nF (recommended capacitor larger than the capacitor for V_{LCD}, V_{SS1} and V_{SS2}).

Higher capacitor values are recommended for ripple reduction.

For COG applications the recommended ITO track resistance is to be minimized for the I/O and supply connections. Maximum values for supply tracks (R_{supply}) are 120 Ω. Maximum values for the common resistance to the source, (R_{common}) are 120 Ω. Higher track resistance reduces performance and increases current consumption.

Three I/O lines are required for the COG module; SDA, SCL and $\overline{\text{RES}}$ (optional). Other signals may be fixed on the module to appropriate levels. R_{I/O} should also be minimized. In particular, if the I²C-bus acknowledge or temperature read back is required, the R_{I/O} for the SDA line must be carefully considered in conjunction with the value of the external pull-up resistor.

65 × 133 pixel matrix driver

PCF8535

14 BONDING PAD LOCATIONS

Table 22 Bonding pad locations

All x and y coordinates are referenced to the centre of the chip (dimensions in μm ; see Fig.27).

SYMBOL	PAD	x	y
dummy	1	-1050	-6156
bump/align 1	2	+1050	-6081
R0	3	+1050	-5985
R1	4	+1050	-5915
R2	5	+1050	-5845
R3	6	+1050	-5775
R4	7	+1050	-5705
R5	8	+1050	-5635
R6	9	+1050	-5565
R7	10	+1050	-5495
R8	11	+1050	-5425
R9	12	+1050	-5355
R10	13	+1050	-5285
R11	14	+1050	-5215
R12	15	+1050	-5145
R13	16	+1050	-5075
R14	17	+1050	-5005
R15	18	+1050	-4935
C0	19	+1050	-4725
C1	20	+1050	-4655
C2	21	+1050	-4585
C3	22	+1050	-4515
C4	23	+1050	-4445
C5	24	+1050	-4305
C6	25	+1050	-4235
C7	26	+1050	-4165
C8	27	+1050	-4095
C9	28	+1050	-4025
C10	29	+1050	-3955
C11	30	+1050	-3885
C12	31	+1050	-3815
C13	32	+1050	-3745
C14	33	+1050	-3675
C15	34	+1050	-3605
C16	35	+1050	-3535
C17	36	+1050	-3465
C18	37	+1050	-3395

SYMBOL	PAD	x	y
C19	38	+1050	-3325
C20	39	+1050	-3255
C21	40	+1050	-3185
C22	41	+1050	-3115
C23	42	+1050	-3045
C24	43	+1050	-2975
C25	44	+1050	-2905
C26	45	+1050	-2835
C27	46	+1050	-2765
C28	47	+1050	-2695
C29	48	+1050	-2625
C30	49	+1050	-2555
C31	50	+1050	-2485
C32	51	+1050	-2415
C33	52	+1050	-2345
C34	53	+1050	-2275
C35	54	+1050	-2205
C36	55	+1050	-2135
C37	56	+1050	-1995
C38	57	+1050	-1925
C39	58	+1050	-1855
C40	59	+1050	-1785
C41	60	+1050	-1715
C42	61	+1050	-1645
C43	62	+1050	-1575
C44	63	+1050	-1505
C45	64	+1050	-1435
C46	65	+1050	-1365
C47	66	+1050	-1295
C48	67	+1050	-1225
C49	68	+1050	-1155
C50	69	+1050	-1085
C51	70	+1050	-1015
C52	71	+1050	-945
C53	72	+1050	-875
C54	73	+1050	-805
C55	74	+1050	-735
C56	75	+1050	-665
C57	76	+1050	-595
C58	77	+1050	-525
C59	78	+1050	-455

65 × 133 pixel matrix driver

PCF8535

SYMBOL	PAD	x	y
C60	79	+1050	-385
C61	80	+1050	-315
C62	81	+1050	-245
C63	82	+1050	-175
C64	83	+1050	-105
C65	84	+1050	-35
C66	85	+1050	+35
C67	86	+1050	+105
C68	87	+1050	+175
C69	88	+1050	+315
C70	89	+1050	+385
C71	90	+1050	+455
C72	91	+1050	+525
C73	92	+1050	+595
C74	93	+1050	+665
C75	94	+1050	+735
C76	95	+1050	+805
C77	96	+1050	+875
C78	97	+1050	+945
C79	98	+1050	+1015
C80	99	+1050	+1085
C81	100	+1050	+1155
C82	101	+1050	+1225
C83	102	+1050	+1295
C84	103	+1050	+1365
C85	104	+1050	+1435
C86	105	+1050	+1505
C87	106	+1050	+1575
C88	107	+1050	+1645
C89	108	+1050	+1715
C90	109	+1050	+1785
C91	110	+1050	+1855
C92	111	+1050	+1925
C93	112	+1050	+1995
C94	113	+1050	+2065
C95	114	+1050	+2135
C96	115	+1050	+2205
C97	116	+1050	+2275
C98	117	+1050	+2345
C99	118	+1050	+2415
C100	119	+1050	+2485

SYMBOL	PAD	x	y
C101	120	+1050	+2625
C102	121	+1050	+2695
C103	122	+1050	+2765
C104	123	+1050	+2835
C105	124	+1050	+2905
C106	125	+1050	+2975
C107	126	+1050	+3045
C108	127	+1050	+3115
C109	128	+1050	+3185
C110	129	+1050	+3255
C111	130	+1050	+3325
C112	131	+1050	+3395
C113	132	+1050	+3465
C114	133	+1050	+3535
C115	134	+1050	+3605
C116	135	+1050	+3675
C117	136	+1050	+3745
C118	137	+1050	+3815
C119	138	+1050	+3885
C120	139	+1050	+3955
C121	140	+1050	+4025
C122	141	+1050	+4095
C123	142	+1050	+4165
C124	143	+1050	+4235
C125	144	+1050	+4305
C126	145	+1050	+4375
C127	146	+1050	+4445
C128	147	+1050	+4515
C129	148	+1050	+4585
C130	149	+1050	+4655
C131	150	+1050	+4725
C132	151	+1050	+4795
R47	152	+1050	+5005
R46	153	+1050	+5075
R45	154	+1050	+5145
R44	155	+1050	+5215
R43	156	+1050	+5285
R42	157	+1050	+5355
R41	158	+1050	+5425
R40	159	+1050	+5495
R39	160	+1050	+5565

65 × 133 pixel matrix driver

PCF8535

SYMBOL	PAD	x	y
R38	161	+1050	+5635
R37	162	+1050	+5705
R36	163	+1050	+5775
R35	164	+1050	+5845
R34	165	+1050	+5915
R33	166	+1050	+5985
bump/align 2	167	+1050	+6081
dummy	168	-1050	+6094
R48	169	-1050	+5954
R49	170	-1050	+5884
R50	171	-1050	+5814
R51	172	-1050	+5744
R52	173	-1050	+5674
R53	174	-1050	+5604
R54	175	-1050	+5534
R55	176	-1050	+5464
R56	177	-1050	+5394
R57	178	-1050	+5324
R58	179	-1050	+5254
R59	180	-1050	+5184
R60	181	-1050	+5114
R61	182	-1050	+5044
R62	183	-1050	+4974
R63	184	-1050	+4904
R64	185	-1050	+4834
bump/align 3	186	-1050	+4414
dummy	187	-1050	+4274
dummy	188	-1050	+3996
dummy	189	-1050	+3574
OSC	190	-1050	+3154
V _{LCDIN}	191	-1050	+2874
V _{LCDIN}	192	-1050	+2804
V _{LCDIN}	193	-1050	+2734
V _{LCDIN}	194	-1050	+2664
V _{LCDIN}	195	-1050	+2594
V _{LCDIN}	196	-1050	+2524
V _{LCDOUT}	197	-1050	+2384
V _{LCDOUT}	198	-1050	+2314
V _{LCDOUT}	199	-1050	+2244
V _{LCDOUT}	200	-1050	+2174
V _{LCDOUT}	201	-1050	+2104

SYMBOL	PAD	x	y
V _{LCDOUT}	202	-1050	+2034
V _{LCDOUT}	203	-1050	+1964
V _{LCDSENCE}	204	-1050	+1894
dummy	205	-1050	+1544
dummy	206	-1050	+1264
RES	207	-1050	+914
T3	208	-1050	+704
T2	209	-1050	+494
T1	210	-1050	+284
V _{DD2}	211	-1050	+144
V _{DD2}	212	-1050	+74
V _{DD2}	213	-1050	+4
V _{DD2}	214	-1050	-66
V _{DD2}	215	-1050	-136
V _{DD2}	216	-1050	-206
V _{DD2}	217	-1050	-276
V _{DD2}	218	-1050	-346
V _{DD3}	219	-1050	-416
V _{DD3}	220	-1050	-486
V _{DD3}	221	-1050	-556
V _{DD3}	222	-1050	-626
V _{DD1}	223	-1050	-696
V _{DD1}	224	-1050	-766
V _{DD1}	225	-1050	-836
V _{DD1}	226	-1050	-906
V _{DD1}	227	-1050	-976
V _{DD1}	228	-1050	-1046
dummy	229	-1050	-1186
SDA	230	-1050	-1466
SDA	231	-1050	-1536
SDAOUT	232	-1050	-1886
SA1	233	-1050	-2166
SA0	234	-1050	-2376
V _{SS2}	235	-1050	-2586
V _{SS2}	236	-1050	-2656
V _{SS2}	237	-1050	-2726
V _{SS2}	238	-1050	-2796
V _{SS2}	239	-1050	-2866
V _{SS2}	240	-1050	-2936
V _{SS2}	241	-1050	-3006
V _{SS2}	242	-1050	-3076

65 × 133 pixel matrix driver

PCF8535

SYMBOL	PAD	x	y
V _{SS1}	243	-1050	-3146
V _{SS1}	244	-1050	-3216
V _{SS1}	245	-1050	-3286
V _{SS1}	246	-1050	-3356
V _{SS1}	247	-1050	-3426
V _{SS1}	248	-1050	-3496
V _{SS1}	249	-1050	-3566
V _{SS1}	250	-1050	-3636
T5	251	-1050	-3846
T4	252	-1050	-4056
dummy	253	-1050	-4126
SCL	254	-1050	-4406
SCL	255	-1050	-4476
bump/align 4	256	-1050	-4605
R32	257	-1050	-4826
R31	258	-1050	-4896
R30	259	-1050	-4966
R29	260	-1050	-5036
R28	261	-1050	-5106
R27	262	-1050	-5176
R26	263	-1050	-5246
R25	264	-1050	-5316
R24	265	-1050	-5386
R23	266	-1050	-5456
R22	267	-1050	-5526
R21	268	-1050	-5596
R20	269	-1050	-5666
R19	270	-1050	-5736
R18	271	-1050	-5806
R17	272	-1050	-5876
R16	273	-1050	-5946

Table 23 Alignment marks

MARKS	x	y
Alignment mark 1	-1045	-4720
Alignment mark 2	-1045	+4620
Alignment mark 3	+1045	+6196
Alignment mark 4	+1045	-6196
Dummy bump/alignment mark 1	+1050	-6081
Dummy bump/alignment mark 2	+1050	+6081
Dummy bump/alignment mark 3	-1050	+4414
Dummy bump/alignment mark 4	-1050	-4605
Bottom left	-1180	-6330
Top right	+1180	+6330

Table 24 Bonding pads

PAD	SIZE	UNIT
Pad pitch	minimum 70	µm
Pad size; Al	62 × 100	µm
CBB opening	36 × 76	µm
Bump dimensions	50 × 90 × 17.5 (± 5)	µm
Wafer thickness (including bumps)	maximum 381	µm

65 × 133 pixel matrix driver

PCF8535

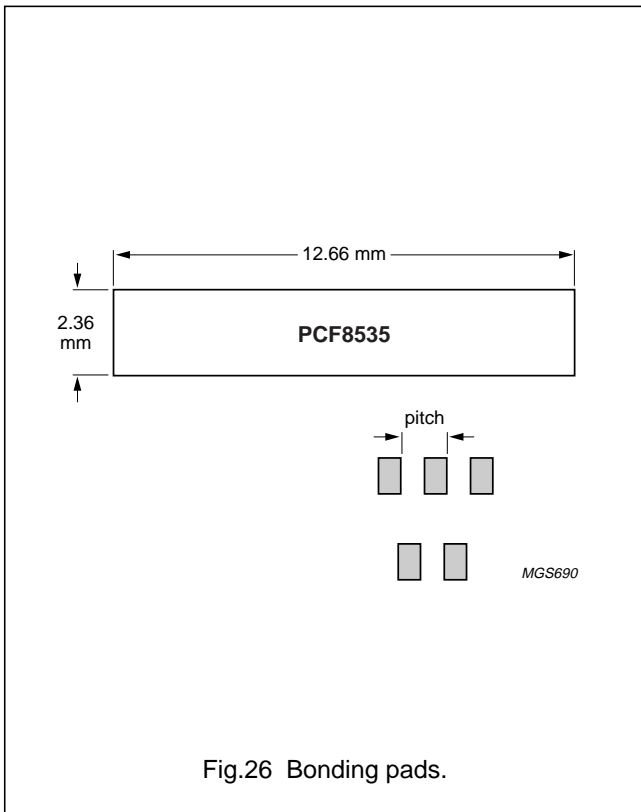
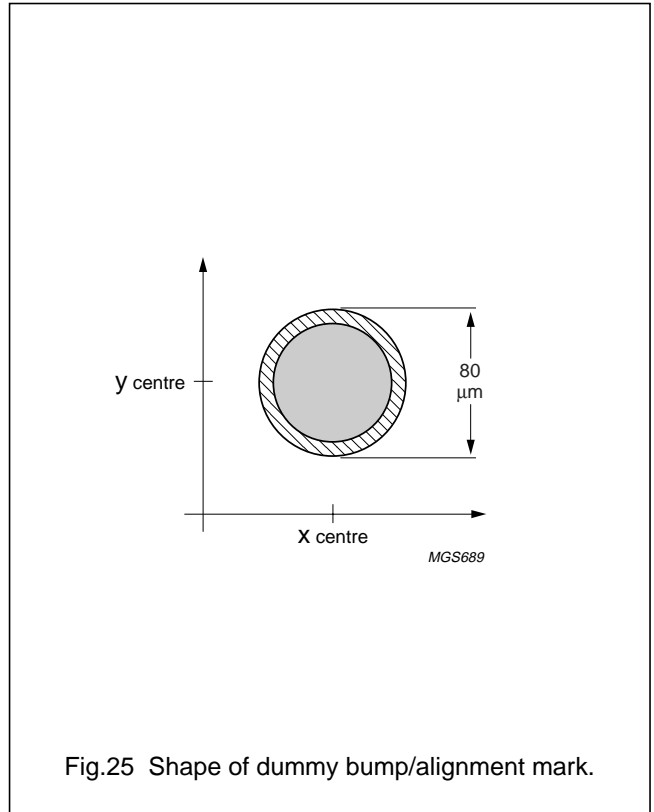
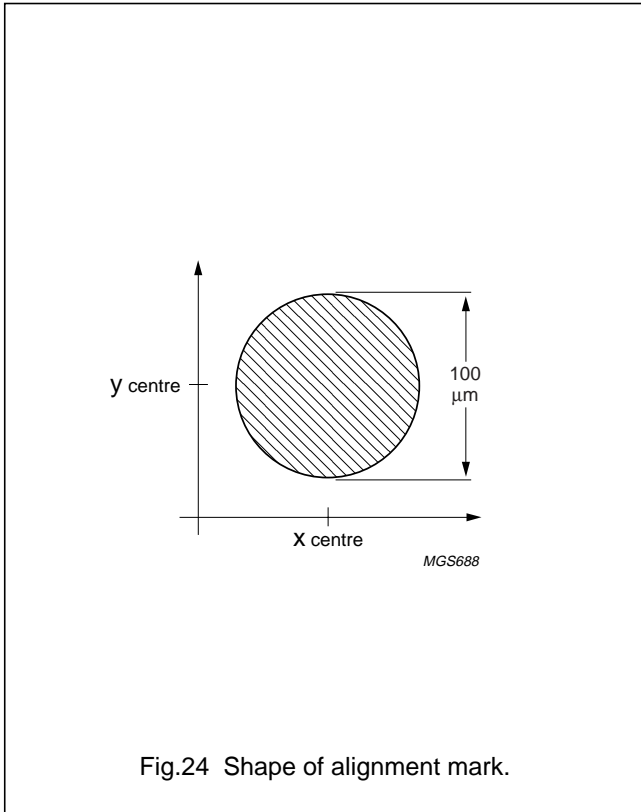

65 × 133 pixel matrix driver

PCF8535

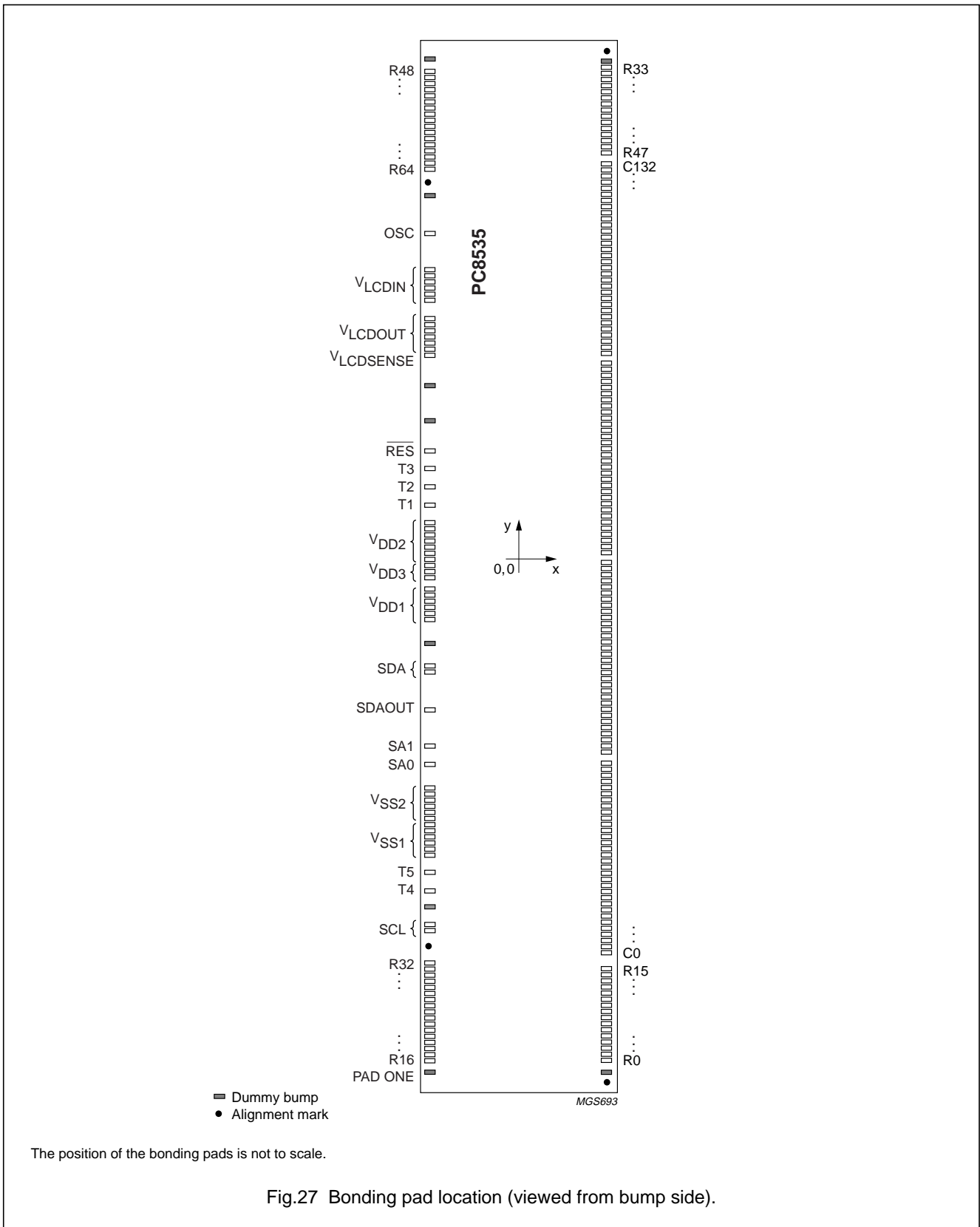

65 × 133 pixel matrix driver

PCF8535

16 TRAY INFORMATION

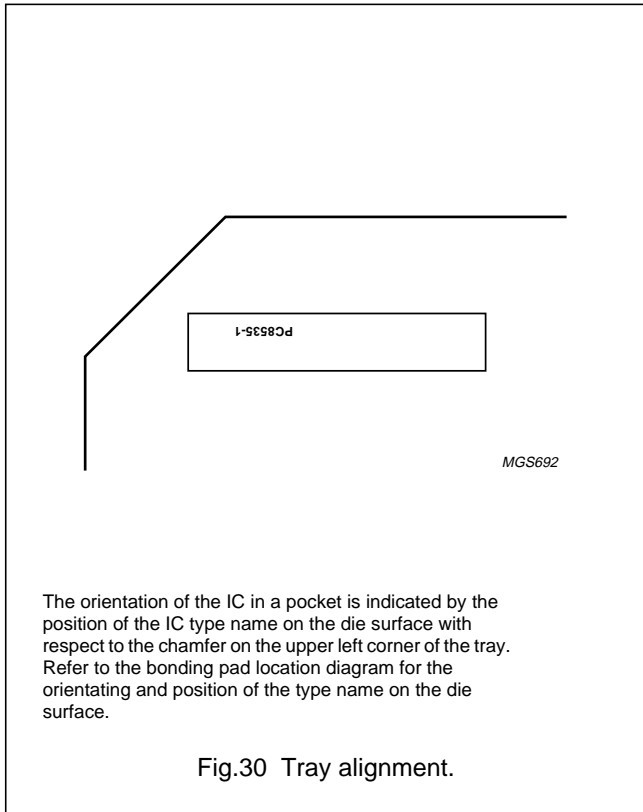
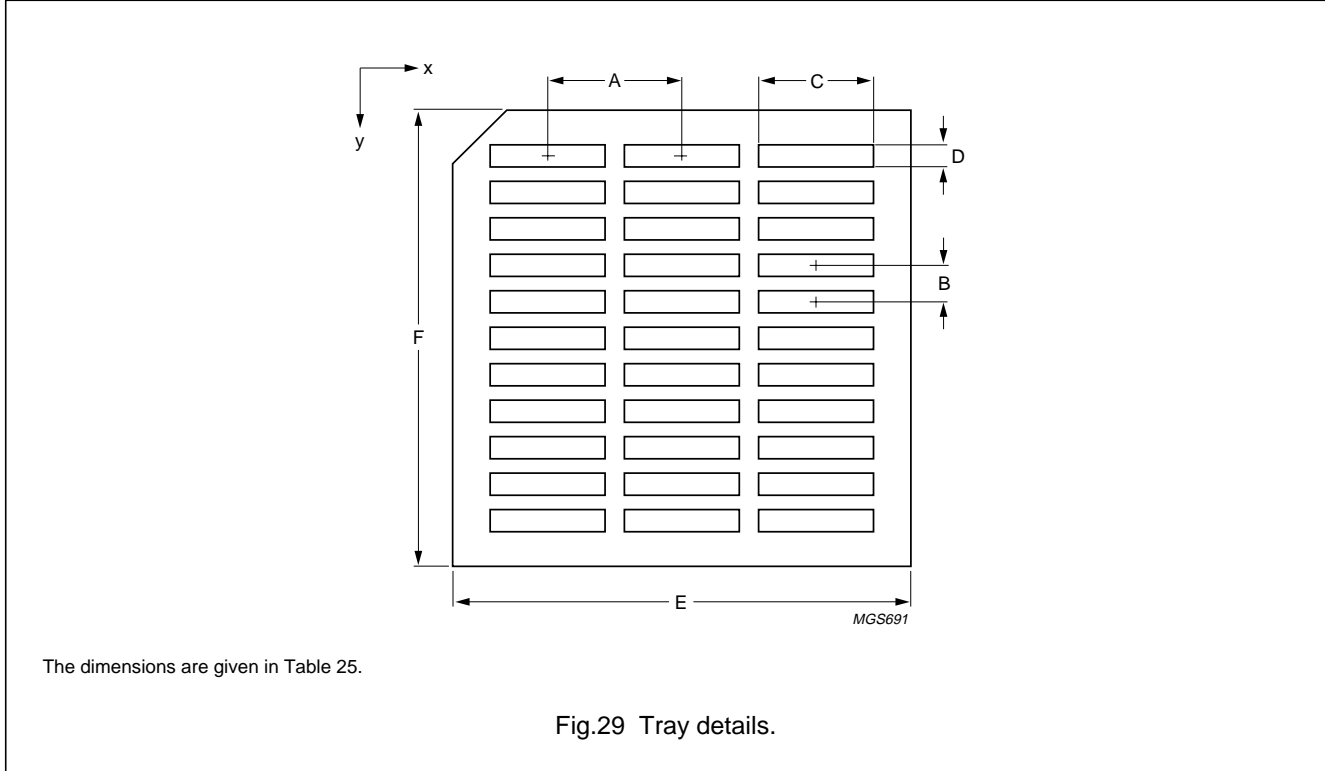

Table 25 Dimensions

DIM.	DESCRIPTION	VALUE
A	pocket pitch in x direction	14.88 mm
B	pocket pitch in y direction	4.06 mm
C	pocket width in x direction	12.76 mm
D	pocket width in y direction	2.46 mm
E	tray width in x direction	50.8 mm
F	tray width in y direction	50.8 mm
x	number of pockets in x direction	3
y	number of pockets in y direction	11

65 × 133 pixel matrix driver

PCF8535

17 DEFINITIONS

Data sheet status	
Objective specification	This data sheet contains target or goal specifications for product development.
Preliminary specification	This data sheet contains preliminary data; supplementary data may be published later.
Product specification	This data sheet contains final product specifications.
Limiting values	
Limiting values given are in accordance with the Absolute Maximum Rating System (IEC 134). Stress above one or more of the limiting values may cause permanent damage to the device. These are stress ratings only and operation of the device at these or at any other conditions above those given in the Characteristics sections of the specification is not implied. Exposure to limiting values for extended periods may affect device reliability.	
Application information	
Where application information is given, it is advisory and does not form part of the specification.	

18 LIFE SUPPORT APPLICATIONS

These products are not designed for use in life support appliances, devices, or systems where malfunction of these products can reasonably be expected to result in personal injury. Philips customers using or selling these products for use in such applications do so at their own risk and agree to fully indemnify Philips for any damages resulting from such improper use or sale.

19 PURCHASE OF PHILIPS I²C COMPONENTS



Purchase of Philips I²C components conveys a license under the Philips' I²C patent to use the components in the I²C system provided the system conforms to the I²C specification defined by Philips. This specification can be ordered using the code 9398 393 40011.

20 BARE DIE DISCLAIMER

All die are tested and are guaranteed to comply with all data sheet limits up to the point of wafer sawing for a period of ninety (90) days from the date of Philips' delivery. If there are data sheet limits not guaranteed, these will be separately indicated in the data sheet. There is no post wafer pack testing performed on individual die. Although the most modern processes are utilized for wafer sawing and die pick and place into wafer pack carriers, Philips Semiconductors has no control of third party procedures in the handling, packing or assembly of the die. Accordingly, Philips Semiconductors assumes no liability for device functionality or performance of the die or systems after handling, packing or assembly of the die. It is the responsibility of the customer to test and qualify their application in which the die is used.

65 × 133 pixel matrix driver

PCF8535

NOTES

Philips Semiconductors – a worldwide company

Argentina: see South America

Australia: 3 Figtree Drive, HOMEBUSH, NSW 2140,
Tel. +61 2 9704 8141, Fax. +61 2 9704 8139

Austria: Computerstr. 6, A-1101 WIEN, P.O. Box 213,
Tel. +43 1 60 101 1248, Fax. +43 1 60 101 1210

Belarus: Hotel Minsk Business Center, Bld. 3, r. 1211, Volodarski Str. 6,
220050 MINSK, Tel. +375 172 20 0733, Fax. +375 172 20 0773

Belgium: see The Netherlands

Brazil: see South America

Bulgaria: Philips Bulgaria Ltd., Energoproject, 15th floor,
51 James Bourchier Blvd., 1407 SOFIA,
Tel. +359 2 68 9211, Fax. +359 2 68 9102

Canada: PHILIPS SEMICONDUCTORS/COMPONENTS,
Tel. +1 800 234 7381, Fax. +1 800 943 0087

China/Hong Kong: 501 Hong Kong Industrial Technology Centre,
72 Tat Chee Avenue, Kowloon Tong, HONG KONG,
Tel. +852 2319 7888, Fax. +852 2319 7700

Colombia: see South America

Czech Republic: see Austria

Denmark: Sydhavnsgade 23, 1780 COPENHAGEN V,
Tel. +45 33 29 3333, Fax. +45 33 29 3905

Finland: Sinikalliontie 3, FIN-02630 ESPOO,
Tel. +358 9 615 800, Fax. +358 9 6158 0920

France: 51 Rue Carnot, BP317, 92156 SURESNES Cedex,
Tel. +33 1 4099 6161, Fax. +33 1 4099 6427

Germany: Hammerbrookstraße 69, D-20097 HAMBURG,
Tel. +49 40 2353 60, Fax. +49 40 2353 6300

Hungary: see Austria

India: Philips INDIA Ltd, Band Box Building, 2nd floor,
254-D, Dr. Annie Besant Road, Worli, MUMBAI 400 025,
Tel. +91 22 493 8541, Fax. +91 22 493 0966

Indonesia: PT Philips Development Corporation, Semiconductors Division,
Gedung Philips, Jl. Buncit Raya Kav.99-100, JAKARTA 12510,
Tel. +62 21 794 0040 ext. 2501, Fax. +62 21 794 0080

Ireland: Newstead, Clonskeagh, DUBLIN 14,
Tel. +353 1 7640 000, Fax. +353 1 7640 200

Israel: RAPAC Electronics, 7 Kehilat Saloniki St, PO Box 18053,
TEL AVIV 61180, Tel. +972 3 645 0444, Fax. +972 3 649 1007

Italy: PHILIPS SEMICONDUCTORS, Via Casati, 23 - 20052 MONZA (MI),
Tel. +39 039 203 6838, Fax +39 039 203 6800

Japan: Philips Bldg 13-37, Kohnan 2-chome, Minato-ku,
TOKYO 108-8507, Tel. +81 3 3740 5130, Fax. +81 3 3740 5057

Korea: Philips House, 260-199 Itaewon-dong, Yongsan-ku, SEOUL,
Tel. +82 2 709 1412, Fax. +82 2 709 1415

Malaysia: No. 76 Jalan Universiti, 46200 PETALING JAYA, SELANGOR,
Tel. +60 3 750 5214, Fax. +60 3 757 4880

Mexico: 5900 Gateway East, Suite 200, EL PASO, TEXAS 79905,
Tel. +9-5 800 234 7381, Fax +9-5 800 943 0087

Middle East: see Italy

Netherlands: Postbus 90050, 5600 PB EINDHOVEN, Bldg. VB,
Tel. +31 40 27 82785, Fax. +31 40 27 88399

New Zealand: 2 Wagener Place, C.P.O. Box 1041, AUCKLAND,
Tel. +64 9 849 4160, Fax. +64 9 849 7811

Norway: Box 1, Manglerud 0612, OSLO,
Tel. +47 22 74 8000, Fax. +47 22 74 8341

Pakistan: see Singapore

Philippines: Philips Semiconductors Philippines Inc.,
106 Valero St. Salcedo Village, P.O. Box 2108 MCC, MAKATI,
Metro MANILA, Tel. +63 2 816 6380, Fax. +63 2 817 3474

Poland: Ul. Lukiska 10, PL 04-123 WARSZAWA,
Tel. +48 22 612 2831, Fax. +48 22 612 2327

Portugal: see Spain

Romania: see Italy

Russia: Philips Russia, Ul. Usatcheva 35A, 119048 MOSCOW,
Tel. +7 095 755 6918, Fax. +7 095 755 6919

Singapore: Lorong 1, Toa Payoh, SINGAPORE 319762,
Tel. +65 350 2538, Fax. +65 251 6500

Slovakia: see Austria

Slovenia: see Italy

South Africa: S.A. PHILIPS Pty Ltd., 195-215 Main Road Martindale,
2092 JOHANNESBURG, P.O. Box 58088 Newville 2114,
Tel. +27 11 471 5401, Fax. +27 11 471 5398

South America: Al. Vicente Pinzon, 173, 6th floor,
04547-130 SÃO PAULO, SP, Brazil,
Tel. +55 11 821 2333, Fax. +55 11 821 2382

Spain: Balmes 22, 08007 BARCELONA,
Tel. +34 93 301 6312, Fax. +34 93 301 4107

Sweden: Kottbygatan 7, Akalla, S-16485 STOCKHOLM,
Tel. +46 8 5985 2000, Fax. +46 8 5985 2745

Switzerland: Allmendstrasse 140, CH-8027 ZÜRICH,
Tel. +41 1 488 2741 Fax. +41 1 488 3263

Taiwan: Philips Semiconductors, 6F, No. 96, Chien Kuo N. Rd., Sec. 1,
TAIPEI, Taiwan Tel. +886 2 2134 2886, Fax. +886 2 2134 2874

Thailand: PHILIPS ELECTRONICS (THAILAND) Ltd.,
209/2 Sanpavuth-Bangna Road Prakanong, BANGKOK 10260,
Tel. +66 2 745 4090, Fax. +66 2 398 0793

Turkey: Yukari Dudullu, Org. San. Blg., 2.Cad. Nr. 28 81260 Umraniye,
ISTANBUL, Tel. +90 216 522 1500, Fax. +90 216 522 1813

Ukraine: PHILIPS UKRAINE, 4 Patrice Lumumba str., Building B, Floor 7,
252042 KIEV, Tel. +380 44 264 2776, Fax. +380 44 268 0461

United Kingdom: Philips Semiconductors Ltd., 276 Bath Road, Hayes,
MIDDLESEX UB3 5BX, Tel. +44 208 730 5000, Fax. +44 208 754 8421

United States: 811 East Arques Avenue, SUNNYVALE, CA 94088-3409,
Tel. +1 800 234 7381, Fax. +1 800 943 0087

Uruguay: see South America

Vietnam: see Singapore

Yugoslavia: PHILIPS, Trg N. Pasica 5/v, 11000 BEOGRAD,
Tel. +381 11 62 5344, Fax.+381 11 63 5777

For all other countries apply to: Philips Semiconductors,
International Marketing & Sales Communications, Building BE-p, P.O. Box 218,
5600 MD EINDHOVEN, The Netherlands, Fax. +31 40 27 24825

Internet: <http://www.semiconductors.philips.com>

© Philips Electronics N.V. 1999

SCA 67

All rights are reserved. Reproduction in whole or in part is prohibited without the prior written consent of the copyright owner.

The information presented in this document does not form part of any quotation or contract, is believed to be accurate and reliable and may be changed without notice. No liability will be accepted by the publisher for any consequence of its use. Publication thereof does not convey nor imply any license under patent- or other industrial or intellectual property rights.

Printed in The Netherlands

465006/01/pp52

Date of release: 1999 Aug 24

Document order number: 9397 750 06201

Let's make things better.

Philips
Semiconductors



PHILIPS